

BID DOCUMENTS
FOR
2020 Street Program – Contract 1



CITY OF OWOSSO
301 W. MAIN STREET
OWOSSO, MICHIGAN 48867

December 9, 2019

**NOTICE TO BIDDERS
2020 STREET PROGRAM – CONTRACT 1
FOR THE CITY OF OWOSSO, MICHIGAN**

**EAST NORTH STREET
From Hickory Street to Gould Street**

**SUMMIT STREET
From Abbott Street to Rubelman Drive**

Sealed proposals will be received by the city of Owosso for the

2020 STREET PROGRAM – CONTRACT 1

and should be addressed to:

Bid Coordinator
City of Owosso
301 W. Main Street
Owosso, Michigan 48867

Major items include: HMA pavement reconstruction, including sidewalk and curb and gutter, storm sewer construction, and water main construction at various locations within the city of Owosso.

Bids will be accepted until **3:00 p.m. Tuesday, January 14, 2020** for the **2020 Street Program – Contract 1** at which time bids will be publicly opened and read aloud. This bid will be considered “All or None”.

“All or None” means that bidders are required to submit pricing for all items requested. Any proposal received that does not meet this requirement will be disqualified. If said bid is not listed as “All or None” the City reserves the right to split said bid to our best benefit.

All bids must be in writing and must contain an original signature by an authorized officer of the firm. Electronic bids (i.e., telephonic, fax, email, etc.) are **NOT** acceptable.

All bids must be accompanied by a certified Cashier's Check or Bid Bond for a sum of not less than 5% of the total bid and shall be made payable to the city of Owosso. This amount shall be forfeited in the case of failure on the part of the successful bidder to sign a contract and furnish satisfactory bonds as required within ten (10) consecutive calendar days after the acceptance of the bid by the city of Owosso.

The bidder agrees that if the city accepts their proposal, the bidder will, within 10 consecutive calendar days after receiving notice of this acceptance, enter into a contract to furnish all labor, equipment and tools necessary to execute the work at the unit prices named in the bid proposal and will furnish the surety for performance, for one hundred percent (100%) of this bid, which shall be accepted and approved by the city.

All bids shall clearly contain on the outside of the **sealed** envelope in which they are submitted:

2020 STREET PROGRAM – CONTRACT 1

Hard copies of the proposal, contract forms and specifications are on file and may be obtained for a fee in accordance with the city's FOIA Policy at the office of the Bid Coordinator, City Hall, 301 West Main Street, Owosso, Michigan 48867. Bid documents are available at no charge on our website at www.ci.owosso.mi.us or on the MITN website at www.mitn.info.

The city reserves the right to accept any proposal; or to reject any proposal; to waive irregularities in a proposal; or to negotiate if it appears to be in the best interest of the city of Owosso.

No work can begin before April 20, 2020 and all work is to be completed by September 19, 2020.

INQUIRIES/ADDENDUMS

Addendums will be available on the city's website at www.ci.owosso.mi.us and on the MITN website at www.mitn.info.

All inquiries regarding this bid request must be submitted to Clayton Wehner and received at least five (5) calendar days prior to the submission and shall be received in, and responded to, in writing, or via FAX at 989-723-8854 or by e-mail to: clayton.wehner@ci.owosso.mi.us , Call 989-725-0551 to arrange a field inspection.

INSTRUCTIONS TO BIDDERS

1. Each proposal must be signed by the bidder with his usual signature. Bids by partnerships should be signed with the partnership name by one of the members of the partnership or by an authorized representative, followed by the signature and title of the person signing. Proposals by corporations must be signed with the name of the corporation, followed by the signature and designation of the president, vice-president or person authorized to bind it in the matter. **Any paperwork not filled out properly or signed will cause the bid to be considered non-responsive and shall be rejected by the city.**
2. Proposals, to receive consideration, must be received prior to the specified time of opening and reading as designated in the invitation.
3. Bidders are requested to use the proposal form furnished by the city when submitting their proposals. Envelopes must be **sealed** when submitted and clearly marked on the outside indicating the name of the bid.
4. Proposals having erasures or corrections thereon may be rejected unless explained or noted over the signature of the bidder.
5. References in the specifications or description of materials, supplies, equipment, or services to a particular trade name, manufacturer's catalog, or model number are made for descriptive purposes to guide the bidder in interpreting the type of materials or supplies, equipment, or nature of the work desired. They should not be construed as excluding proposals on equivalent types of materials, supplies, and equipment or for performing the work in a manner other than specified. However, the bidders' attention is called to General Condition seven (7).
6. Proposals should be mailed or delivered to: Bid Coordinator's Office, City Hall, 301 W. Main Street, Owosso, MI 48867.
7. Special conditions included in this inquiry shall take precedence over any conditions listed under General Conditions or Instructions to Bidders.
8. Insurance coverage – The winning bidder, prior to execution of the contract, shall file with the city copies of completed certificates of insurance naming the city of Owosso as an additional insured party, as evidence that the contractor carries adequate insurance satisfactory to the city.
9. **The following items must be included with the bid response:**
 - a. **Vendor Proposal**
 - b. **W-9 Request for Taxpayer ID No. and Certification**
 - c. **Signature Page & Legal Status/ Acknowledgement of Addendum(s)insurance Endorsement**

BID Proposal

**2020 STREET PROGRAM
CONTRACT 1**

TO: THE CITY OF OWOSSO (HEREINAFTER CALLED THE “CITY”)

Bidder must provide pricing for each item listed. If additional pricing elements are being offered by the bidder, they are to be listed under “other services/items offered.”

The undersigned, having examined the bid proposal forms and specifications, does hereby offer to **2020 STREET PROGRAM – CONTRACT 1** from **April 20, 2020** through **September 19, 2020** listed below at the following prices to wit:

Road and Storm Sewer (Bid Items 1-80):

| Item | Description | Approx. Quantity | Unit | Unit Price | Total Price |
|-------------|---|-------------------------|-------------|-------------------|--------------------|
| 1 | Mobilization, Max \$85,500 (Road and Storm) | 1 | LSUM | | |
| 2 | Tree, Rem, 6 inch to 18 inch | 1 | Ea | | |
| 3 | Dr Structure, Rem | 35 | Ea | | |
| 4 | Sewer, Rem, Less than 24 inch | 2,509 | Ft | | |
| 5 | Sewer, Rem, 24 inch to 48 inch | 32 | Ft | | |
| 6 | Curb and Gutter, Rem | 6,345 | Ft | | |
| 7 | Pavt, Rem | 923 | Syd | | |
| 8 | Sidewalk, Rem | 577 | Syd | | |
| 9 | Embankment, CIP | 1,375 | Cyd | | |

| Item | Description | Approx. Quantity | Unit | Unit Price | Total Price |
|-------------|--|-------------------------|-------------|-------------------|--------------------|
| 10 | Excavation, Earth | 3,910 | Cyd | | |
| 11 | Subbase, CIP | 223 | Cyd | | |
| 12 | Subgrade Undercutting, Type II | 400 | Cyd | | |
| 13 | Erosion Control, Inlet Protection, Fabric Drop | 32 | Ea | | |
| 14 | Aggregate Base, 6 inch, Modified | 1,682 | Syd | | |
| 15 | Aggregate Base, 8 inch, Modified | 15,507 | Syd | | |
| 16 | Maintenance Gravel | 200 | Ton | | |
| 17 | Geotextile, Separator, Modified | 17,189 | Syd | | |
| 18 | Sewer, SDR-26, 10 inch, Tr Det B, Modified | 407 | Ft | | |
| 19 | Sewer, SDR-26, 12 inch, Tr Det B, Modified | 620 | Ft | | |
| 20 | Sewer, SDR-26, 15 inch, Tr Det B, Modified | 654 | Ft | | |
| 21 | Sewer, SDR-26, 18 inch, Tr Det B, Modified | 298 | Ft | | |
| 22 | Sewer, SDR-26, 24 inch, Tr Det B, Modified | 427 | Ft | | |
| 23 | Sewer Bulkhead, 12 inch | 5 | Ea | | |

| Item | Description | Approx. Quantity | Unit | Unit Price | Total Price |
|-------------|---|-------------------------|-------------|-------------------|--------------------|
| 24 | Sewer Tap, 12 inch | 1 | Ea | | |
| 25 | Sewer Tap, 18 inch | 1 | Ea | | |
| 26 | Dr Structure, Temp Lowering | 17 | Ea | | |
| 27 | Dr Structure Cover, Adj, Case 1 | 19 | Ea | | |
| 28 | Dr Structure Tap, 12 inch | 1 | Ea | | |
| 29 | Dr Structure Collar, Modified | 16 | Ea | | |
| 30 | Dr Structure Cover, EJ 1040 w/ Vented Gasket Sealed Cover | 14 | Ea | | |
| 31 | Dr Structure Cover, EJ 1040 w/ Solid Gasket Sealed Cover | 17 | Ea | | |
| 32 | Dr Structure Cover, EJ 7000 | 23 | Ea | | |
| 33 | Dr Structure 36 inch dia, Modified | 22 | Ea | | |
| 34 | Dr Structure 48 inch dia, Modified | 12 | Ea | | |
| 35 | Dr Structure 60 inch dia, Modified | 2 | Ea | | |
| 36 | Dr Structure, 72 inch dia, Modified | 1 | Ea | | |
| 37 | HMA Surface, Rem | 17,331 | Syd | | |

| Item | Description | Approx. Quantity | Unit | Unit Price | Total Price |
|-------------|---|-------------------------|-------------|-------------------|--------------------|
| 38 | Hand Patching | 10 | Ton | | |
| 39 | HMA, 3E3 | 3,081 | Ton | | |
| 40 | HMA, 4E3 | 824 | Ton | | |
| 41 | HMA, 5E3 | 1,403 | Ton | | |
| 42 | HMA Approach | 15 | Ton | | |
| 43 | Cement | 2 | Ton | | |
| 44 | Saw Cutting | 200 | Ft | | |
| 45 | Driveway, Nonreinf Conc, 6 inch | 1,000 | Syd | | |
| 46 | Driveway, Nonreinf Conc, 9 inch | 250 | Syd | | |
| 47 | Approach, CI II, LM | 10 | Cyd | | |
| 48 | Curb and Gutter, Conc, Det F4 | 5,044 | Ft | | |
| 49 | Curb and Gutter, Conc, Det F4, Modified | 1,070 | Ft | | |
| 50 | Driveway Opening, Conc, Det M | 256 | Ft | | |
| 51 | Detectable Warning Surface, Modified | 181 | Ft | | |

| Item | Description | Approx. Quantity | Unit | Unit Price | Total Price |
|------|--|------------------|------|------------|-------------|
| 52 | Sidewalk Ramp, Conc, 7 inch | 2,812 | Sft | | |
| 53 | Sidewalk, Conc, 4 inch | 2,018 | Sft | | |
| 54 | Sidewalk, Conc, 6 inch | 2,362 | Sft | | |
| 55 | Sidewalk, Conc, 9 inch | 1,100 | Sft | | |
| 56 | Valve Box, Adj | 5 | Ea | | |
| 57 | Sanitary Serv Conflict | 5 | Ea | | |
| 58 | Abandoned Gas Main Conflict | 10 | Ea | | |
| 59 | Barricade, Type III, High Intensity, Double Sided, Furn & Oper | 21 | Ea | | |
| 60 | Pedestrian Type II Barricade, Temp | 25 | Ea | | |
| 61 | Lighted Arrow, Type C, Furn & Oper | 2 | Ea | | |
| 62 | Minor Traf Devices, Max \$10,000 | 1 | LSUM | | |
| 63 | Plastic Drum, High Intensity, Furn & Oper | 80 | Ea | | |
| 64 | Sign, Type B, Temp, Prismatic, Furn & Oper | 550 | Sft | | |
| 65 | Sign, Portable, Changeable Message, Furn & Oper | 1 | Ea | | |

| Item | Description | Approx. Quantity | Unit | Unit Price | Total Price |
|------|--|------------------|------|------------|-------------|
| 66 | Turf Establishment, Performance | 4,566 | Syd | | |
| 67 | Post, Steel, 3 lb | 480 | Ft | | |
| 68 | Sign, Type III, Erect, Salv | 6 | Ea | | |
| 69 | Sign, Type III, Rem | 14 | Ea | | |
| 70 | Sign, Type IIIB | 150 | Sft | | |
| 71 | Sign, Type V, Rem | 1 | Ea | | |
| 72 | Sign, Type VB | 8 | Sft | | |
| 73 | Pavt Mrkg, Ovly Cold Plastic, 6 inch, Crosswalk | 410 | Ft | | |
| 74 | Pavt Mrkg, Ovly Cold Plastic, 24 inch, Stop Bar | 110 | Ft | | |
| 75 | Pavt Mrkg, Ovly Cold Plastic, Rt Turn Arrow Sym | 2 | Ea | | |
| 76 | Pavt Mrkg, Ovly Cold Plastic, Thru and Lt Turn Arrow Sym | 2 | Ea | | |
| 77 | Pavt Mrkg, Waterborne, 4 inch, White | 165 | Ft | | |
| 78 | Pavt Mrkg, Waterborne, 4 inch, Yellow | 4,420 | Ft | | |
| 79 | Post, Mailbox | 18 | Ea | | |

| Item | Description | Approx. Quantity | Unit | Unit Price | Total Price |
|------|----------------------|------------------|------|------------|-------------|
| 80 | Audio Visual Filming | 1 | LSUM | | |

Bidder's Initial _____

Subtotal of Road and Storm Sewer (Bid Items 1-80):

_____ (use words)

\$ _____ (use figures)

(Note: Bid items 81-99 reserved for Additional Items, if Necessary)

Water Main (Bid Items 100-131):

| Item | Description | Approx. Quantity | Unit | Unit Price | Total Price |
|------|---|------------------|------|------------|-------------|
| 100 | Mobilization, Max \$39,000 (Water Main) | 1 | LSUM | | |
| 101 | Testing and Chlorination of Water Main | 1 | LSUM | | |
| 102 | Connect to Ex. Water Main | 15 | Ea | | |
| 103 | Existing Valve with Valve Box Abandonment | 23 | Ea | | |
| 104 | Hydrant, Rem | 8 | Ea | | |
| 105 | Water Main, Abandon in Place | 3328 | Ft | | |
| 106 | Water Main, C909 PVC, 4 inch, TB Detail G, Modified | 13 | Ft | | |
| 107 | Water Main, C909 PVC, 6 inch, TB Detail G, Modified | 235 | Ft | | |

| Item | Description | Approx. Quantity | Unit | Unit Price | Total Price |
|-------------|--|-------------------------|-------------|-------------------|--------------------|
| 108 | Water Main, C909 PVC, 8 inch, TB Detail G, Modified | 1008 | Ft | | |
| 109 | Water Main, C900 PVC, 8 inch, Bore | 1000 | Ft | | |
| 110 | Water Main, C909 PVC, 12 inch, TB Detail G, Modified | 2494 | Ft | | |
| 111 | Water Main, 4 inch, Cut and Plug, Modified | 1 | Ea | | |
| 112 | Water Main, 6 inch, Cut and Plug, Modified | 16 | Ea | | |
| 113 | Water Main, 8 inch, Cut and Plug, Modified | 2 | Ea | | |
| 114 | Water Main, 12 inch, Cut and Plug, Modified | 2 | Ea | | |
| 115 | Gate Valve and Box, 4 inch, Modified | 1 | Ea | | |
| 116 | Gate Valve and Box, 6 inch, Modified | 3 | Ea | | |
| 117 | Gate Valve and Box, 8 inch, Modified | 11 | Ea | | |
| 118 | Gate Valve and Box, 12 inch, Modified | 6 | Ea | | |
| 119 | Fire Hydrant and Valve Assembly | 15 | Ea | | |
| 120 | 1" Copper Service Lead, Type "K", Modified | 2588 | Ft | | |
| 121 | Curb Box, Stop, 3/4 inch Corporation Stop Connection, Modified | 61 | Ea | | |

| Item | Description | Approx. Quantity | Unit | Unit Price | Total Price |
|------|--|------------------|------|------------|-------------|
| 122 | Supply & Install Meter Pit, Complete | 15 | Ea | | |
| 123 | Water Meter Pit, Rem | 15 | Ea | | |
| 124 | 2" Blow-Off and Copper Line to Surface | 13 | Ea | | |
| 125 | Sign, Type III, Rem | 10 | Ea | | |
| 126 | Sign, Type III, Erect, Salv | 10 | Ea | | |
| 127 | Post, Steel, 3 Pound | 160 | Ft | | |
| 128 | Sidewalk, Rem | 320 | Syd | | |
| 129 | Sidewalk, Conc, 4 inch | 3500 | Sft | | |
| 130 | Sidewalk, Conc, 6 inch | 350 | Sft | | |
| 131 | Turf Establishment, Performance | 6050 | Syd | | |

Bidder's Initial _____

Subtotal of Water Main (Bid Items 100-131):

_____ (use words)

\$ _____

(use figures)

BID TOTAL

Total of all Road and Storm Sewer (Bid Items 1-80) and Water Main (Bid Items 100-131):

_____ (use words)

\$ _____ (use figures)

Bidder's Initial _____

VARIANCE FROM SPECIFICATIONS: If the bidder is unable to comply with the specifications as outlined, the bidder shall clearly note these variations from the specifications. The bidder may also propose additions to these specifications for the city to consider, but the costs associated with these additions shall be stated separately.

If the work is not complete on or before the date set for completion or any extension, the Contractor shall pay the city liquidated damages of **\$1,550.00** a calendar day until the work is satisfactorily completed. Liquidated damages for delay may be deducted from payments due the contractor or may be collected from the Contractor or the Contractor's surety.

The undersigned agrees that if the city accepts this proposal, Contractor will, within 10 consecutive calendar days after receiving notice of this acceptance, enter into a contract to furnish all labor, equipment and tools necessary to execute the work at the unit prices named in the bid proposal. Contractor will furnish the surety for performance, for 100% of this bid, which shall be accepted and approved by the city.

The undersigned agrees that if the city accepts this proposal, Contractor will start this project no sooner than **April 20, 2020** and will substantially complete the entire work under this contract by **September 19, 2020**. This schedule may be extended for rain days or cold weather for calendar days after **September 19, 2020**, only as approved by the city of Owosso.

On behalf of _____, I hereby submit this proposal for **2020 STREET PROGRAM – CONTRACT 1** for your consideration. The undersigned acknowledges that this proposal is subject to the General Conditions and the General Specifications included in the contract documents. In submitting this proposal, it is understood that the right is reserved by the CITY to reject any and all proposals, and waive any irregularities in the bidding process. The CITY may award this contract based on any combination of the total bid and/or alternates.

Dated and signed at _____ State of _____

This _____ day of _____, 20____.

Bidder

Witness:

By/s/

Business Address

Signature

Printed Name

Title

Telephone Number

E-Mail Address

GENERAL CONDITIONS

1. BID ACCEPTANCE

The city reserves the right to reject any or all proposals. Unless otherwise specified, the city reserves the right to accept any item in the proposal. In case of error in extending the total amount of the bid, the unit prices shall govern. The city objects to any additional terms stated in any documents submitted by the contractor. Performance pursuant to our Purchase Order/Equipment Agreement constitutes a course of conduct consisting of Contractor's Agreement to the terms of our Purchase Order/Equipment Agreement.

2. PAYMENT

Unless otherwise stated by the bidder, time, concerning discount offered, will be computed from date of delivery and acceptance at destination or from date correct bill or claim voucher properly certified by the contractor is received. When so stated herein, partial payments, based on a certified approved estimate by the city of materials, supplies or equipment delivered or work done, may be made upon presentation of a properly-executed claim voucher. The final payment will be made by the city when materials, supplies, equipment or the work done have been fully delivered or completed to the full satisfaction of the city.

3. BID DEFAULT

In case of default by the bidder or contractor, the city of Owosso may procure the articles or services from other sources and hold the bidder or contractor responsible for any excess cost occasioned thereby.

4. UNIT PRICES

Prices should be stated in units of quantity specified.

5. QUOTED PRICES

Unless otherwise stated by the bidder, prices quoted will be considered as being based on delivery to a designated destination and to include all charges for packing, crating, containers, shipping, etc., and being in strict accordance with specifications and standards as shown.

6. SUBSTITUTIONS

Wherever a reference is made in the specifications or description of the materials, supplies, equipment, or services required, to a particular trade name, manufacturer's catalog, or model number, the bidder, if awarded a contract or order, will be required to furnish the particular item referred to in strict accordance with the specifications or description unless a departure or substitution is clearly noted and described in the proposal.

7. HOLD CITY HARMLESS

The bidder, if awarded an order or contract, agrees to protect, defend, and save the city harmless against any demand for payment for the use of any patented material, process, article, or device that may enter into the manufacture, construction, or form a part of the work covered by either order or contract. Bidder further agrees to indemnify and save the city harmless from suits or action of every nature and description brought against it, for or on account of any injuries or damages received or sustained by any party or parties, by or from any of the acts of the contractor, his employees, subcontractors, or agents.

8. COMPETITIVE BIDDING STATUTES

The laws of the state of Michigan, the charter and ordinances of the city of Owosso, as far as they apply to the laws of competitive bidding, contracts and purchases, are made a part hereof.

9. SAMPLES

Samples, when requested, must be furnished free of expense to the city and, if not destroyed, will upon request be returned at the bidder' expense.

10. BONDS

A certified check or bid bond may be required, payable to the City of Owosso. If so required in the bid documents, a performance bond and labor and material bond in the amounts stated in the bid documents, shall be on file with the city before work commences. The city will determine the amount and sufficiency of the sureties.

11. PROPOSAL GUARANTEE

All checks or bid bonds, except those of the three lowest bidders, will be returned when the bids have been opened and tabulated. The certified checks or bid bonds of the three lowest bidders will be held until the contract documents have been signed, after which remaining certified checks or bid bonds will be returned to the respective bidders.

12. BIDDERS

The city may demand that the contractor file a sworn experience and financial statement setting forth the financial resources, adequacy of plant and equipment, organization, experience and other pertinent and material facts as may be desirable.

13. INSURANCE AND HOLD HARMLESS

To the fullest extent permitted by law the Contractor agrees to defend, pay on behalf of, indemnify, and hold harmless the City of Owosso, its elected and appointed officials, employees, agents and volunteers, and others working on behalf of the City of Owosso against any and all claims, demands, suits, or loss, including all costs connected therewith, and for any damages which may be asserted, claimed, or recovered against or from the City of Owosso, by reason of personal injury, including bodily injury or death and/or property damage, including loss of use thereof, for all actions of the Contractor.

Contractor shall not commence work under this contract until they have obtained the insurance required under this paragraph, and shall keep such insurance in force during the entire life of this contract. All coverage shall be with insurance companies licensed and admitted to do business in the State of Michigan and acceptable to the City of Owosso. The requirements below should not be interpreted to limit the liability of Contractor. All deductibles and SIR's are the responsibility of Contractor. Contractor shall procure and maintain the following insurance coverage:

- a. Worker's Compensation Insurance including Employers' Liability Coverage, in accordance with all applicable statutes of the State of Michigan.
- b. Commercial General Liability Insurance on an "Occurrence Basis" with limits of liability not less than \$3,000,000 per occurrence and aggregate. Coverage shall include the following extensions: (A) Contractual Liability; (B) Products and Completed Operations; (C) Independent Contractors Coverage; (D) Broad Form General Liability Extensions or equivalent, if not already included. (E) Explosion, Collapse, and Underground (XCU) coverage, if applicable. Limits may be obtained by the use of primary and excess/umbrella liability policies.
- c. Automobile Liability including Michigan No-Fault Coverages, with limits of liability not less than \$3,000,000 per occurrence, combined single limit for Bodily Injury, and Property Damage. Coverage shall include all owned vehicles, all non-owned vehicles, and all hired vehicles.

- d. Owners' and Contractor Protective Liability: The Contractor shall procure and maintain during the life of this contract, a separate Owners' and Contractor's Protective Liability Policy with limits of liability not less than \$3,000,000 per occurrence and aggregate for Personal Injury, Bodily Injury, and Property Damage. The City of Owosso shall be the "Named Insured" on said coverage.
- e. Additional Insured: Commercial General Liability and Automobile Liability as described above shall include an endorsement stating the City of Owosso shall be listed as additional insured. It is understood and agreed by naming the City of Owosso as additional insured, coverage afforded is considered to be primary and any other insurance the City of Owosso may have in effect shall be considered secondary and/or excess.
- f. Cancellation Notice: All policies, as described above, shall include an endorsement stating that it is understood and agreed Thirty (30) days, Ten (10) days for non-payment of premium, Advance Written Notice of Cancellation, shall be sent to: **(The City of Owosso, Debbie Hebert, Insurance Coordinator, 301 W. Main Street, Owosso, MI 48867).**
- g. Proof of Insurance Coverage: Contractor shall provide the City of Owosso at the time that the contracts are returned by him/her for execution, a Certificate of Insurance as well as the required endorsements. In lieu of required endorsements, if applicable, a copy of the policy sections where coverage is provided for additional insured and cancellation notice would be acceptable.

If any of the above coverages expire during the term of this contract, the Contractor shall deliver renewal certificates and endorsements to the City of Owosso at least ten (10) days prior to the expiration date.

14. PROTECTION OF LAND MONUMENTS AND PROPERTY STAKES

Land monuments or stakes marking property corners shall not be moved or otherwise disturbed except as directed by the city. If any land monuments or lot stakes are moved or disturbed by the contractor, the cost of replacing each land monument or lot stake so moved or disturbed shall be deducted from any money due the contractor, as payment to the city for the cost of replacing said land monument or lot stakes.

15. CONTRACTOR'S RESPONSIBILITY FOR WORK

The contractor shall be responsible for any damages that the work may sustain before its acceptance, and shall rebuild, repair, restore and make good, at its own expense, all injuries and damages to any portion of the work by the action of the elements or from any cause whatsoever before its acceptance. Neither the final payment nor any provision in the contract documents shall relieve the contractor of the responsibility for negligence or faulty materials or workmanship within the extent and period provided by law, and, upon written notice, the contractor shall remove any defects due therefrom and pay for any damaged due to other work resulting therefrom, which shall appear within one year after the date of completion and acceptance.

16. PAYMENT

At monthly intervals commencing after construction has been started, the city will make partial payment to the contractor based on a duly-certified estimate prepared by the city of the work done by the contractor during the preceding four-week period. Each estimate will be submitted to the city council for approval on either the first or third Monday of each month. The city will retain ten percent (10%) of the amount of each such estimate until final completion and acceptance of all work covered by this contract. Before the contractor shall demand final estimates or payment, contractor will furnish to the city, supported by sworn statements, satisfactory evidence that all persons that have supplied labor, materials,

or equipment for the work embraced under this contract have been fully paid for the same; and that, in case such evidence be not furnished as aforesaid, such sums as the city may deem necessary to meet the lawful claims of such persons may be retained by the city from any monies that may be due or become due to the contractor under this contract until such liabilities shall be fully discharged and the evidence thereof be furnished to the city.

17. CITY'S RIGHT TO WITHHOLD CERTAIN AMOUNTS AND MAKE APPLICATION THEREOF

Besides the payment to be retained by the city under the preceding provisions of these general conditions, the city may withhold a sufficient amount of any payment otherwise due to the contractor to cover a) payments earned or due for just claims for furnish labor or materials on the project under this contract, b) for defective work not remedied and c) for failure of the contractor to make proper payments to subcontractors. The city shall disburse and shall have the right to act as agent for the contractor in disbursing such funds as have been previously withheld pursuant to this paragraph to the party or parties who are entitled to payment from it. The city will pay to the contractor a proper accounting of all such funds disbursed for the contractor.

18. OWNER'S RIGHT TO DO WORK

If the contractor should neglect to prosecute the work properly or fail to perform any provisions of this contract, the city, after three (3) days' written notice to the contractor and contractor's surety, may without prejudice to any other remedy he may have, make good such deficiencies and may deduct the cost of it from the payment due the contractor.

19. DEFINITION OF NOTICE

Where in any of the contract documents there is any provision in respect to the giving of notice, such notice shall be deemed given to the owner, when written notice is delivered to the city manager, or placed in the United States mail addressed to the city clerk; as to the contractor, when a written notice shall be delivered to contractor's representative at the project site or by mailing such written notice in the United States mail addressed to the contractor at the place stated in the bid proposal as the business address; as to the surety on the performance bond, when a written notice is placed in the United States mail addressed to the surety at the surety's home office or to its agent or agents who executed such performance bond on behalf of the surety.

20. SUBCONTRACTS

The contractor shall not subcontract any work in the execution of this contract without the written consent of the city. The contractor shall be responsible for the acts or omissions of any subcontractor and of anyone employed directly or indirectly by such subcontractor.

21. ASSIGNMENT OF CONTRACT

The contractor shall not assign this contract or any part hereof without the written consent of the city. No assignment shall be valid unless it shall contain a provision that any funds to be paid to the assignee under this agreement are subject to a prior lien for services rendered or materials or supplies for the performance of the work specified in the contract in favor of all persons, firms, or corporations rendering such services or supplying such materials.

22. MAINTAINING TRAFFIC

The contractor shall provide flares, signs, barricades, traffic regulators, etc., to conform to the current *Michigan Manual of Uniform Traffic Control Devices* or as directed by the city. The contractor shall not close any road or street without the permission of the city. If any street or road is to be closed by the contractor, it shall be the responsibility of the contractor to notify the Owosso fire department when the street will be closed and again when the street is open to traffic. Traffic control devices for any detours

deemed necessary by the city shall be provided by the contractor. Cost of maintaining shall be incidental to the cost of the project unless otherwise provided.

23. ORDER OF COMPLETION

The contractor shall submit, whenever requested by the city, a schedule of the work showing completion dates. The city may request that certain portions of the work be done before other portions. If so requested, the contractor shall arrange to schedule to meet the request by the owner.

24. USE OF COMPLETED PORTIONS

The city shall have the right to take possession and use any completed or partially completed portions of the work; but such taking possession and use shall not be deemed acceptance. Pending final completion and acceptance of the work, all necessary repairs and adjustments on any section of the work due to defective material, workmanship, natural causes, or other operations of the contractor, other than normal wear and tear, shall be done by and at the expense of the contractor.

25. WATER SUPPLY

The contractor shall secure an adequate water supply for use in construction and for drinking water for his employees. If the city's water is used on the work, the contractor shall make the necessary application and shall pay all costs involved. Connections, piping and fittings for conveying water shall be furnished and maintained by the contractor. Contractor shall pay for water according to the city's established rates.

26. CLEANUP

The contractor shall keep the project free from waste materials or rubbish caused by its employees or work. This includes as a minimum excess excavation or backfill material, broken or rejected materials, empty containers or general debris. The owner may require complete cleanup of certain areas as construction is completed.

27. SUPERVISION

The contractor shall have a superintendent on the job site to coordinate and expedite the various construction activities for the duration of this contract.

29. EQUAL EMPLOYMENT OPPORTUNITY AND OTHER CLAUSES

The contractor shall agree not to discriminate against any employee or applicant for employment because of age, race, religion, color, handicap, sex, physical condition, developmental disability as defined by Michigan Compiled Statutes, or national origin. This provision shall include but not be limited to the following: employment, upgrading, demotion or transfer, recruitment or recruitment advertising, layoff or termination, rate of pay or other forms of compensation, and selection for training including apprenticeship. The contractor further agrees to take affirmative action to ensure equal employment opportunities for persons with disabilities. The contractor agrees to post in conspicuous places, available to employees and applicants for employment, notices setting forth the provision of the non-discrimination clause.

SIGNATURE PAGE AND LEGAL STATUS

The undersigned certifies that he is an official legally authorized to bind his firm and to enter into a contract should the city accept this proposal.

Bid proposal by _____
(Name of Firm)

Legal status of bidder. Please check the appropriate box and **USE CORRECT LEGAL NAME.**

A. Corporation ____ ; State of Incorporation _____

B. Partnership ____ ; List of names _____

C. DBA ____ ; State full name _____ DBA

D. Other ____ ; Explain _____

Signature of Bidder _____ Title _____
(Authorized Signature)

Printed name _____

Signature of Bidder _____ Title _____
(Authorized Signature)

Printed name _____

Address _____ City _____ Zip _____

Telephone () _____

Signed this _____ day of _____ 20____.

Bidder acknowledges receipt of the following Addenda:

| ADDENDUM NO. | BIDDER'S INITIALS |
|--------------|-------------------|
| _____ | _____ |
| _____ | _____ |
| _____ | _____ |

W-9 INFORMATION FOR LEGAL STATUS

Sole proprietor. Enter your individual name as shown on your income tax return on the “Name” line. You may enter your business, trade, or “doing business as (DBA)” name on the “Business name/disregarded entity name” line.

Partnership, C Corporation, or S Corporation. Enter the entity's name on the “Name” line and any business, trade, or “doing business as (DBA) name” on the “Business name/disregarded entity name” line.

Disregarded entity. Enter the owner's name on the “Name” line. The name of the entity entered on the “Name” line should never be a disregarded entity. The name on the “Name” line must be the name shown on the income tax return on which the income will be reported. For example, if a foreign LLC that is treated as a disregarded entity for U.S. federal tax purposes has a domestic owner, the domestic owner's name is required to be provided on the “Name” line. If the direct owner of the entity is also a disregarded entity, enter the first owner that is not disregarded for federal tax purposes. Enter the disregarded entity's name on the “Business name/disregarded entity name” line. If the owner of the disregarded entity is a foreign person, you must complete an appropriate Form W-8.

Note. Check the appropriate box for the federal tax classification of the person whose name is entered on the “Name” line (Individual/sole proprietor, Partnership, C Corporation, S Corporation, Trust/estate).

Limited Liability Company (LLC). If the person identified on the “Name” line is an LLC, check the “Limited liability company” box only and enter the appropriate code for the tax classification in the space provided. If you are an LLC that is treated as a partnership for federal tax purposes, enter “P” for partnership. If you are an LLC that has filed a Form 8832 or a Form 2553 to be taxed as a corporation, enter “C” for C corporation or “S” for S corporation. If you are an LLC that is disregarded as an entity separate from its owner under Regulation section 301.7701-3 (except for employment and excise tax), do not check the LLC box unless the owner of the LLC (required to be identified on the “Name” line) is another LLC that is not disregarded for federal tax purposes. If the LLC is disregarded as an entity separate from its owner, enter the appropriate tax classification of the owner identified on the “Name” line.

Other entities. Enter your business name as shown on required federal tax documents on the “Name” line. This name should match the name shown on the charter or other legal document creating the entity. You may enter any business, trade, or DBA name on the “Business name/disregarded entity name” line.

Please see attached W-9 Request for Taxpayer Identification Number and Certification form for a detailed explanation on filling out the W-9 form.

Request for Taxpayer Identification Number and Certification

**Give Form to the
 requester. Do not
 send to the IRS.**

▶ Go to www.irs.gov/FormW9 for instructions and the latest information.

| | | |
|---|---|--|
| Print or type. See Specific Instructions on page 3. | 1 Name (as shown on your income tax return). Name is required on this line; do not leave this line blank. | |
| | 2 Business name/disregarded entity name, if different from above | |
| | 3 Check appropriate box for federal tax classification of the person whose name is entered on line 1. Check only one of the following seven boxes. | 4 Exemptions (codes apply only to certain entities, not individuals; see instructions on page 3): |
| | <input type="checkbox"/> Individual/sole proprietor or single-member LLC <input type="checkbox"/> C Corporation <input type="checkbox"/> S Corporation <input type="checkbox"/> Partnership <input type="checkbox"/> Trust/estate | Exempt payee code (if any) _____ |
| | <input type="checkbox"/> Limited liability company. Enter the tax classification (C=C corporation, S=S corporation, P=Partnership) ▶ _____ Note: Check the appropriate box in the line above for the tax classification of the single-member owner. Do not check LLC if the LLC is classified as a single-member LLC that is disregarded from the owner unless the owner of the LLC is another LLC that is not disregarded from the owner for U.S. federal tax purposes. Otherwise, a single-member LLC that is disregarded from the owner should check the appropriate box for the tax classification of its owner. | Exemption from FATCA reporting code (if any) _____ |
| | <input type="checkbox"/> Other (see instructions) ▶ _____ | <small>(Applies to accounts maintained outside the U.S.)</small> |
| | 5 Address (number, street, and apt. or suite no.) See instructions. | Requester's name and address (optional) |
| 6 City, state, and ZIP code | | |
| 7 List account number(s) here (optional) | | |

Part I Taxpayer Identification Number (TIN)

Enter your TIN in the appropriate box. The TIN provided must match the name given on line 1 to avoid backup withholding. For individuals, this is generally your social security number (SSN). However, for a resident alien, sole proprietor, or disregarded entity, see the instructions for Part I, later. For other entities, it is your employer identification number (EIN). If you do not have a number, see *How to get a TIN*, later.

Note: If the account is in more than one name, see the instructions for line 1. Also see *What Name and Number To Give the Requester* for guidelines on whose number to enter.

| | | | | | | | | | |
|---------------------------------------|--|--|--|---|--|--|---|--|--|
| Social security number | | | | | | | | | |
| | | | | - | | | - | | |
| or | | | | | | | | | |
| Employer identification number | | | | | | | | | |
| | | | | - | | | | | |

Part II Certification

Under penalties of perjury, I certify that:

1. The number shown on this form is my correct taxpayer identification number (or I am waiting for a number to be issued to me); and
2. I am not subject to backup withholding because: (a) I am exempt from backup withholding, or (b) I have not been notified by the Internal Revenue Service (IRS) that I am subject to backup withholding as a result of a failure to report all interest or dividends, or (c) the IRS has notified me that I am no longer subject to backup withholding; and
3. I am a U.S. citizen or other U.S. person (defined below); and
4. The FATCA code(s) entered on this form (if any) indicating that I am exempt from FATCA reporting is correct.

Certification instructions. You must cross out item 2 above if you have been notified by the IRS that you are currently subject to backup withholding because you have failed to report all interest and dividends on your tax return. For real estate transactions, item 2 does not apply. For mortgage interest paid, acquisition or abandonment of secured property, cancellation of debt, contributions to an individual retirement arrangement (IRA), and generally, payments other than interest and dividends, you are not required to sign the certification, but you must provide your correct TIN. See the instructions for Part II, later.

| | | |
|------------------|----------------------------|--------|
| Sign Here | Signature of U.S. person ▶ | Date ▶ |
|------------------|----------------------------|--------|

General Instructions

Section references are to the Internal Revenue Code unless otherwise noted.

Future developments. For the latest information about developments related to Form W-9 and its instructions, such as legislation enacted after they were published, go to www.irs.gov/FormW9.

Purpose of Form

An individual or entity (Form W-9 requester) who is required to file an information return with the IRS must obtain your correct taxpayer identification number (TIN) which may be your social security number (SSN), individual taxpayer identification number (ITIN), adoption taxpayer identification number (ATIN), or employer identification number (EIN), to report on an information return the amount paid to you, or other amount reportable on an information return. Examples of information returns include, but are not limited to, the following.

- Form 1099-INT (interest earned or paid)

- Form 1099-DIV (dividends, including those from stocks or mutual funds)
- Form 1099-MISC (various types of income, prizes, awards, or gross proceeds)
- Form 1099-B (stock or mutual fund sales and certain other transactions by brokers)
- Form 1099-S (proceeds from real estate transactions)
- Form 1099-K (merchant card and third party network transactions)
- Form 1098 (home mortgage interest), 1098-E (student loan interest), 1098-T (tuition)
- Form 1099-C (canceled debt)
- Form 1099-A (acquisition or abandonment of secured property)

Use Form W-9 only if you are a U.S. person (including a resident alien), to provide your correct TIN.

If you do not return Form W-9 to the requester with a TIN, you might be subject to backup withholding. See What is backup withholding, later.

By signing the filled-out form, you:

1. Certify that the TIN you are giving is correct (or you are waiting for a number to be issued),
2. Certify that you are not subject to backup withholding, or
3. Claim exemption from backup withholding if you are a U.S. exempt payee. If applicable, you are also certifying that as a U.S. person, your allocable share of any partnership income from a U.S. trade or business is not subject to the withholding tax on foreign partners' share of effectively connected income, and
4. Certify that FATCA code(s) entered on this form (if any) indicating that you are exempt from the FATCA reporting, is correct. See *What is FATCA reporting*, later, for further information.

Note: If you are a U.S. person and a requester gives you a form other than Form W-9 to request your TIN, you must use the requester's form if it is substantially similar to this Form W-9.

Definition of a U.S. person. For federal tax purposes, you are considered a U.S. person if you are:

- An individual who is a U.S. citizen or U.S. resident alien;
- A partnership, corporation, company, or association created or organized in the United States or under the laws of the United States;
- An estate (other than a foreign estate); or
- A domestic trust (as defined in Regulations section 301.7701-7).

Special rules for partnerships. Partnerships that conduct a trade or business in the United States are generally required to pay a withholding tax under section 1446 on any foreign partners' share of effectively connected taxable income from such business. Further, in certain cases where a Form W-9 has not been received, the rules under section 1446 require a partnership to presume that a partner is a foreign person, and pay the section 1446 withholding tax. Therefore, if you are a U.S. person that is a partner in a partnership conducting a trade or business in the United States, provide Form W-9 to the partnership to establish your U.S. status and avoid section 1446 withholding on your share of partnership income.

In the cases below, the following person must give Form W-9 to the partnership for purposes of establishing its U.S. status and avoiding withholding on its allocable share of net income from the partnership conducting a trade or business in the United States.

- In the case of a disregarded entity with a U.S. owner, the U.S. owner of the disregarded entity and not the entity;
- In the case of a grantor trust with a U.S. grantor or other U.S. owner, generally, the U.S. grantor or other U.S. owner of the grantor trust and not the trust; and
- In the case of a U.S. trust (other than a grantor trust), the U.S. trust (other than a grantor trust) and not the beneficiaries of the trust.

Foreign person. If you are a foreign person or the U.S. branch of a foreign bank that has elected to be treated as a U.S. person, do not use Form W-9. Instead, use the appropriate Form W-8 or Form 8233 (see Pub. 515, *Withholding of Tax on Nonresident Aliens and Foreign Entities*).

Nonresident alien who becomes a resident alien. Generally, only a nonresident alien individual may use the terms of a tax treaty to reduce or eliminate U.S. tax on certain types of income. However, most tax treaties contain a provision known as a "saving clause." Exceptions specified in the saving clause may permit an exemption from tax to continue for certain types of income even after the payee has otherwise become a U.S. resident alien for tax purposes.

If you are a U.S. resident alien who is relying on an exception contained in the saving clause of a tax treaty to claim an exemption from U.S. tax on certain types of income, you must attach a statement to Form W-9 that specifies the following five items.

1. The treaty country. Generally, this must be the same treaty under which you claimed exemption from tax as a nonresident alien.
2. The treaty article addressing the income.
3. The article number (or location) in the tax treaty that contains the saving clause and its exceptions.
4. The type and amount of income that qualifies for the exemption from tax.
5. Sufficient facts to justify the exemption from tax under the terms of the treaty article.

Example. Article 20 of the U.S.-China income tax treaty allows an exemption from tax for scholarship income received by a Chinese student temporarily present in the United States. Under U.S. law, this student will become a resident alien for tax purposes if his or her stay in the United States exceeds 5 calendar years. However, paragraph 2 of the first Protocol to the U.S.-China treaty (dated April 30, 1984) allows the provisions of Article 20 to continue to apply even after the Chinese student becomes a resident alien of the United States. A Chinese student who qualifies for this exception (under paragraph 2 of the first protocol) and is relying on this exception to claim an exemption from tax on his or her scholarship or fellowship income would attach to Form W-9 a statement that includes the information described above to support that exemption.

If you are a nonresident alien or a foreign entity, give the requester the appropriate completed Form W-8 or Form 8233.

Backup Withholding

What is backup withholding? Persons making certain payments to you must under certain conditions withhold and pay to the IRS 24% of such payments. This is called "backup withholding." Payments that may be subject to backup withholding include interest, tax-exempt interest, dividends, broker and barter exchange transactions, rents, royalties, nonemployee pay, payments made in settlement of payment card and third party network transactions, and certain payments from fishing boat operators. Real estate transactions are not subject to backup withholding.

You will not be subject to backup withholding on payments you receive if you give the requester your correct TIN, make the proper certifications, and report all your taxable interest and dividends on your tax return.

Payments you receive will be subject to backup withholding if:

1. You do not furnish your TIN to the requester,
2. You do not certify your TIN when required (see the instructions for Part II for details),
3. The IRS tells the requester that you furnished an incorrect TIN,
4. The IRS tells you that you are subject to backup withholding because you did not report all your interest and dividends on your tax return (for reportable interest and dividends only), or
5. You do not certify to the requester that you are not subject to backup withholding under 4 above (for reportable interest and dividend accounts opened after 1983 only).

Certain payees and payments are exempt from backup withholding. See *Exempt payee code*, later, and the separate Instructions for the Requester of Form W-9 for more information.

Also see *Special rules for partnerships*, earlier.

What is FATCA Reporting?

The Foreign Account Tax Compliance Act (FATCA) requires a participating foreign financial institution to report all United States account holders that are specified United States persons. Certain payees are exempt from FATCA reporting. See *Exemption from FATCA reporting code*, later, and the Instructions for the Requester of Form W-9 for more information.

Updating Your Information

You must provide updated information to any person to whom you claimed to be an exempt payee if you are no longer an exempt payee and anticipate receiving reportable payments in the future from this person. For example, you may need to provide updated information if you are a C corporation that elects to be an S corporation, or if you no longer are tax exempt. In addition, you must furnish a new Form W-9 if the name or TIN changes for the account; for example, if the grantor of a grantor trust dies.

Penalties

Failure to furnish TIN. If you fail to furnish your correct TIN to a requester, you are subject to a penalty of \$50 for each such failure unless your failure is due to reasonable cause and not to willful neglect.

Civil penalty for false information with respect to withholding. If you make a false statement with no reasonable basis that results in no backup withholding, you are subject to a \$500 penalty.

Criminal penalty for falsifying information. Willfully falsifying certifications or affirmations may subject you to criminal penalties including fines and/or imprisonment.

Misuse of TINs. If the requester discloses or uses TINs in violation of federal law, the requester may be subject to civil and criminal penalties.

Specific Instructions

Line 1

You must enter one of the following on this line; **do not** leave this line blank. The name should match the name on your tax return.

If this Form W-9 is for a joint account (other than an account maintained by a foreign financial institution (FFI)), list first, and then circle, the name of the person or entity whose number you entered in Part I of Form W-9. If you are providing Form W-9 to an FFI to document a joint account, each holder of the account that is a U.S. person must provide a Form W-9.

a. **Individual.** Generally, enter the name shown on your tax return. If you have changed your last name without informing the Social Security Administration (SSA) of the name change, enter your first name, the last name as shown on your social security card, and your new last name.

Note: ITIN applicant: Enter your individual name as it was entered on your Form W-7 application, line 1a. This should also be the same as the name you entered on the Form 1040/1040A/1040EZ you filed with your application.

b. **Sole proprietor or single-member LLC.** Enter your individual name as shown on your 1040/1040A/1040EZ on line 1. You may enter your business, trade, or “doing business as” (DBA) name on line 2.

c. **Partnership, LLC that is not a single-member LLC, C corporation, or S corporation.** Enter the entity’s name as shown on the entity’s tax return on line 1 and any business, trade, or DBA name on line 2.

d. **Other entities.** Enter your name as shown on required U.S. federal tax documents on line 1. This name should match the name shown on the charter or other legal document creating the entity. You may enter any business, trade, or DBA name on line 2.

e. **Disregarded entity.** For U.S. federal tax purposes, an entity that is disregarded as an entity separate from its owner is treated as a “disregarded entity.” See Regulations section 301.7701-2(c)(2)(iii). Enter the owner’s name on line 1. The name of the entity entered on line 1 should never be a disregarded entity. The name on line 1 should be the name shown on the income tax return on which the income should be reported. For example, if a foreign LLC that is treated as a disregarded entity for U.S. federal tax purposes has a single owner that is a U.S. person, the U.S. owner’s name is required to be provided on line 1. If the direct owner of the entity is also a disregarded entity, enter the first owner that is not disregarded for federal tax purposes. Enter the disregarded entity’s name on line 2, “Business name/disregarded entity name.” If the owner of the disregarded entity is a foreign person, the owner must complete an appropriate Form W-8 instead of a Form W-9. This is the case even if the foreign person has a U.S. TIN.

Line 2

If you have a business name, trade name, DBA name, or disregarded entity name, you may enter it on line 2.

Line 3

Check the appropriate box on line 3 for the U.S. federal tax classification of the person whose name is entered on line 1. Check only one box on line 3.

| IF the entity/person on line 1 is a(n) . . . | THEN check the box for . . . |
|--|---|
| • Corporation | Corporation |
| • Individual • Sole proprietorship, or • Single-member limited liability company (LLC) owned by an individual and disregarded for U.S. federal tax purposes. | Individual/sole proprietor or single-member LLC |
| • LLC treated as a partnership for U.S. federal tax purposes, • LLC that has filed Form 8832 or 2553 to be taxed as a corporation, or • LLC that is disregarded as an entity separate from its owner but the owner is another LLC that is not disregarded for U.S. federal tax purposes. | Limited liability company and enter the appropriate tax classification. (P= Partnership; C= C corporation; or S= S corporation) |
| • Partnership | Partnership |
| • Trust/estate | Trust/estate |

Line 4, Exemptions

If you are exempt from backup withholding and/or FATCA reporting, enter in the appropriate space on line 4 any code(s) that may apply to you.

Exempt payee code.

- Generally, individuals (including sole proprietors) are not exempt from backup withholding.
- Except as provided below, corporations are exempt from backup withholding for certain payments, including interest and dividends.
- Corporations are not exempt from backup withholding for payments made in settlement of payment card or third party network transactions.
- Corporations are not exempt from backup withholding with respect to attorneys’ fees or gross proceeds paid to attorneys, and corporations that provide medical or health care services are not exempt with respect to payments reportable on Form 1099-MISC.

The following codes identify payees that are exempt from backup withholding. Enter the appropriate code in the space in line 4.

- 1—An organization exempt from tax under section 501(a), any IRA, or a custodial account under section 403(b)(7) if the account satisfies the requirements of section 401(f)(2)
- 2—The United States or any of its agencies or instrumentalities
- 3—A state, the District of Columbia, a U.S. commonwealth or possession, or any of their political subdivisions or instrumentalities
- 4—A foreign government or any of its political subdivisions, agencies, or instrumentalities
- 5—A corporation
- 6—A dealer in securities or commodities required to register in the United States, the District of Columbia, or a U.S. commonwealth or possession
- 7—A futures commission merchant registered with the Commodity Futures Trading Commission
- 8—A real estate investment trust
- 9—An entity registered at all times during the tax year under the Investment Company Act of 1940
- 10—A common trust fund operated by a bank under section 584(a)
- 11—A financial institution
- 12—A middleman known in the investment community as a nominee or custodian
- 13—A trust exempt from tax under section 664 or described in section 4947

The following chart shows types of payments that may be exempt from backup withholding. The chart applies to the exempt payees listed above, 1 through 13.

| IF the payment is for . . . | THEN the payment is exempt for . . . |
|--|---|
| Interest and dividend payments | All exempt payees except for 7 |
| Broker transactions | Exempt payees 1 through 4 and 6 through 11 and all C corporations. S corporations must not enter an exempt payee code because they are exempt only for sales of noncovered securities acquired prior to 2012. |
| Barter exchange transactions and patronage dividends | Exempt payees 1 through 4 |
| Payments over \$600 required to be reported and direct sales over \$5,000 ¹ | Generally, exempt payees 1 through 5 ² |
| Payments made in settlement of payment card or third party network transactions | Exempt payees 1 through 4 |

¹ See Form 1099-MISC, Miscellaneous Income, and its instructions.

² However, the following payments made to a corporation and reportable on Form 1099-MISC are not exempt from backup withholding: medical and health care payments, attorneys' fees, gross proceeds paid to an attorney reportable under section 6045(f), and payments for services paid by a federal executive agency.

Exemption from FATCA reporting code. The following codes identify payees that are exempt from reporting under FATCA. These codes apply to persons submitting this form for accounts maintained outside of the United States by certain foreign financial institutions. Therefore, if you are only submitting this form for an account you hold in the United States, you may leave this field blank. Consult with the person requesting this form if you are uncertain if the financial institution is subject to these requirements. A requester may indicate that a code is not required by providing you with a Form W-9 with "Not Applicable" (or any similar indication) written or printed on the line for a FATCA exemption code.

A—An organization exempt from tax under section 501(a) or any individual retirement plan as defined in section 7701(a)(37)

B—The United States or any of its agencies or instrumentalities

C—A state, the District of Columbia, a U.S. commonwealth or possession, or any of their political subdivisions or instrumentalities

D—A corporation the stock of which is regularly traded on one or more established securities markets, as described in Regulations section 1.1472-1(c)(1)(i)

E—A corporation that is a member of the same expanded affiliated group as a corporation described in Regulations section 1.1472-1(c)(1)(i)

F—A dealer in securities, commodities, or derivative financial instruments (including notional principal contracts, futures, forwards, and options) that is registered as such under the laws of the United States or any state

G—A real estate investment trust

H—A regulated investment company as defined in section 851 or an entity registered at all times during the tax year under the Investment Company Act of 1940

I—A common trust fund as defined in section 584(a)

J—A bank as defined in section 581

K—A broker

L—A trust exempt from tax under section 664 or described in section 4947(a)(1)

M—A tax exempt trust under a section 403(b) plan or section 457(g) plan

Note: You may wish to consult with the financial institution requesting this form to determine whether the FATCA code and/or exempt payee code should be completed.

Line 5

Enter your address (number, street, and apartment or suite number). This is where the requester of this Form W-9 will mail your information returns. If this address differs from the one the requester already has on file, write NEW at the top. If a new address is provided, there is still a chance the old address will be used until the payor changes your address in their records.

Line 6

Enter your city, state, and ZIP code.

Part I. Taxpayer Identification Number (TIN)

Enter your TIN in the appropriate box. If you are a resident alien and you do not have and are not eligible to get an SSN, your TIN is your IRS individual taxpayer identification number (ITIN). Enter it in the social security number box. If you do not have an ITIN, see *How to get a TIN* below.

If you are a sole proprietor and you have an EIN, you may enter either your SSN or EIN.

If you are a single-member LLC that is disregarded as an entity separate from its owner, enter the owner's SSN (or EIN, if the owner has one). Do not enter the disregarded entity's EIN. If the LLC is classified as a corporation or partnership, enter the entity's EIN.

Note: See *What Name and Number To Give the Requester*, later, for further clarification of name and TIN combinations.

How to get a TIN. If you do not have a TIN, apply for one immediately. To apply for an SSN, get Form SS-5, Application for a Social Security Card, from your local SSA office or get this form online at www.SSA.gov. You may also get this form by calling 1-800-772-1213. Use Form W-7, Application for IRS Individual Taxpayer Identification Number, to apply for an ITIN, or Form SS-4, Application for Employer Identification Number, to apply for an EIN. You can apply for an EIN online by accessing the IRS website at www.irs.gov/Businesses and clicking on Employer Identification Number (EIN) under Starting a Business. Go to www.irs.gov/Forms to view, download, or print Form W-7 and/or Form SS-4. Or, you can go to www.irs.gov/OrderForms to place an order and have Form W-7 and/or SS-4 mailed to you within 10 business days.

If you are asked to complete Form W-9 but do not have a TIN, apply for a TIN and write "Applied For" in the space for the TIN, sign and date the form, and give it to the requester. For interest and dividend payments, and certain payments made with respect to readily tradable instruments, generally you will have 60 days to get a TIN and give it to the requester before you are subject to backup withholding on payments. The 60-day rule does not apply to other types of payments. You will be subject to backup withholding on all such payments until you provide your TIN to the requester.

Note: Entering "Applied For" means that you have already applied for a TIN or that you intend to apply for one soon.

Caution: A disregarded U.S. entity that has a foreign owner must use the appropriate Form W-8.

Part II. Certification

To establish to the withholding agent that you are a U.S. person, or resident alien, sign Form W-9. You may be requested to sign by the withholding agent even if item 1, 4, or 5 below indicates otherwise.

For a joint account, only the person whose TIN is shown in Part I should sign (when required). In the case of a disregarded entity, the person identified on line 1 must sign. Exempt payees, see *Exempt payee code*, earlier.

Signature requirements. Complete the certification as indicated in items 1 through 5 below.

1. Interest, dividend, and barter exchange accounts opened before 1984 and broker accounts considered active during 1983.

You must give your correct TIN, but you do not have to sign the certification.

2. Interest, dividend, broker, and barter exchange accounts opened after 1983 and broker accounts considered inactive during 1983.

You must sign the certification or backup withholding will apply. If you are subject to backup withholding and you are merely providing your correct TIN to the requester, you must cross out item 2 in the certification before signing the form.

3. Real estate transactions. You must sign the certification. You may cross out item 2 of the certification.

4. Other payments. You must give your correct TIN, but you do not have to sign the certification unless you have been notified that you have previously given an incorrect TIN. "Other payments" include payments made in the course of the requester's trade or business for rents, royalties, goods (other than bills for merchandise), medical and health care services (including payments to corporations), payments to a nonemployee for services, payments made in settlement of payment card and third party network transactions, payments to certain fishing boat crew members and fishermen, and gross proceeds paid to attorneys (including payments to corporations).

5. Mortgage interest paid by you, acquisition or abandonment of secured property, cancellation of debt, qualified tuition program payments (under section 529), ABLE accounts (under section 529A), IRA, Coverdell ESA, Archer MSA or HSA contributions or distributions, and pension distributions. You must give your correct TIN, but you do not have to sign the certification.

What Name and Number To Give the Requester

| For this type of account: | Give name and SSN of: |
|--|---|
| 1. Individual | The individual |
| 2. Two or more individuals (joint account) other than an account maintained by an FFI | The actual owner of the account or, if combined funds, the first individual on the account ¹ |
| 3. Two or more U.S. persons (joint account maintained by an FFI) | Each holder of the account |
| 4. Custodial account of a minor (Uniform Gift to Minors Act) | The minor ² |
| 5. a. The usual revocable savings trust (grantor is also trustee) | The grantor-trustee ¹ |
| b. So-called trust account that is not a legal or valid trust under state law | The actual owner ¹ |
| 6. Sole proprietorship or disregarded entity owned by an individual | The owner ³ |
| 7. Grantor trust filing under Optional Form 1099 Filing Method 1 (see Regulations section 1.671-4(b)(2)(i)(A)) | The grantor* |
| For this type of account: | Give name and EIN of: |
| 8. Disregarded entity not owned by an individual | The owner |
| 9. A valid trust, estate, or pension trust | Legal entity ⁴ |
| 10. Corporation or LLC electing corporate status on Form 8832 or Form 2553 | The corporation |
| 11. Association, club, religious, charitable, educational, or other tax-exempt organization | The organization |
| 12. Partnership or multi-member LLC | The partnership |
| 13. A broker or registered nominee | The broker or nominee |

| For this type of account: | Give name and EIN of: |
|---|-----------------------|
| 14. Account with the Department of Agriculture in the name of a public entity (such as a state or local government, school district, or prison) that receives agricultural program payments | The public entity |
| 15. Grantor trust filing under the Form 1041 Filing Method or the Optional Form 1099 Filing Method 2 (see Regulations section 1.671-4(b)(2)(i)(B)) | The trust |

¹ List first and circle the name of the person whose number you furnish. If only one person on a joint account has an SSN, that person's number must be furnished.

² Circle the minor's name and furnish the minor's SSN.

³ You must show your individual name and you may also enter your business or DBA name on the "Business name/disregarded entity" name line. You may use either your SSN or EIN (if you have one), but the IRS encourages you to use your SSN.

⁴ List first and circle the name of the trust, estate, or pension trust. (Do not furnish the TIN of the personal representative or trustee unless the legal entity itself is not designated in the account title.) Also see *Special rules for partnerships*, earlier.

*Note: The grantor also must provide a Form W-9 to trustee of trust.

Note: If no name is circled when more than one name is listed, the number will be considered to be that of the first name listed.

Secure Your Tax Records From Identity Theft

Identity theft occurs when someone uses your personal information such as your name, SSN, or other identifying information, without your permission, to commit fraud or other crimes. An identity thief may use your SSN to get a job or may file a tax return using your SSN to receive a refund.

To reduce your risk:

- Protect your SSN,
- Ensure your employer is protecting your SSN, and
- Be careful when choosing a tax preparer.

If your tax records are affected by identity theft and you receive a notice from the IRS, respond right away to the name and phone number printed on the IRS notice or letter.

If your tax records are not currently affected by identity theft but you think you are at risk due to a lost or stolen purse or wallet, questionable credit card activity or credit report, contact the IRS Identity Theft Hotline at 1-800-908-4490 or submit Form 14039.

For more information, see Pub. 5027, Identity Theft Information for Taxpayers.

Victims of identity theft who are experiencing economic harm or a systemic problem, or are seeking help in resolving tax problems that have not been resolved through normal channels, may be eligible for Taxpayer Advocate Service (TAS) assistance. You can reach TAS by calling the TAS toll-free case intake line at 1-877-777-4778 or TTY/TDD 1-800-829-4059.

Protect yourself from suspicious emails or phishing schemes.

Phishing is the creation and use of email and websites designed to mimic legitimate business emails and websites. The most common act is sending an email to a user falsely claiming to be an established legitimate enterprise in an attempt to scam the user into surrendering private information that will be used for identity theft.

The IRS does not initiate contacts with taxpayers via emails. Also, the IRS does not request personal detailed information through email or ask taxpayers for the PIN numbers, passwords, or similar secret access information for their credit card, bank, or other financial accounts.

If you receive an unsolicited email claiming to be from the IRS, forward this message to phishing@irs.gov. You may also report misuse of the IRS name, logo, or other IRS property to the Treasury Inspector General for Tax Administration (TIGTA) at 1-800-366-4484. You can forward suspicious emails to the Federal Trade Commission at spam@uce.gov or report them at www.ftc.gov/complaint. You can contact the FTC at www.ftc.gov/idtheft or 877-IDTHEFT (877-438-4338). If you have been the victim of identity theft, see www.IdentityTheft.gov and Pub. 5027.

Visit www.irs.gov/IdentityTheft to learn more about identity theft and how to reduce your risk.

Privacy Act Notice

Section 6109 of the Internal Revenue Code requires you to provide your correct TIN to persons (including federal agencies) who are required to file information returns with the IRS to report interest, dividends, or certain other income paid to you; mortgage interest you paid; the acquisition or abandonment of secured property; the cancellation of debt; or contributions you made to an IRA, Archer MSA, or HSA. The person collecting this form uses the information on the form to file information returns with the IRS, reporting the above information. Routine uses of this information include giving it to the Department of Justice for civil and criminal litigation and to cities, states, the District of Columbia, and U.S. commonwealths and possessions for use in administering their laws. The information also may be disclosed to other countries under a treaty, to federal and state agencies to enforce civil and criminal laws, or to federal law enforcement and intelligence agencies to combat terrorism. You must provide your TIN whether or not you are required to file a tax return. Under section 3406, payers must generally withhold a percentage of taxable interest, dividend, and certain other payments to a payee who does not give a TIN to the payer. Certain penalties may also apply for providing false or fraudulent information.

PROOF OF INSURANCE

This is to certify that the following endorsement is part of the policy(ies) described below:

| NAMED INSURED (CONTRACTOR) | <u>COMPANIES AFFORDING COVERAGE</u> |
|-----------------------------------|--|
| ADDRESS | A. B. C. |

It is hereby understood and agreed that the city of Owosso, its city council and each member thereof and every officer and employee of the city shall be named as joint and several assureds with respect to claims arising out of the following project:

2020 Street Program – Contract 1

It is further agreed that the following indemnity agreement between the city of Owosso and the named insured is covered under this policy: Contractor agrees to indemnify, hold harmless and defend city, its city council and each member thereof and every officer and employee of city from any and all liability or financial loss resulting from any suits, claims, losses or actions brought against and from all costs and expenses of litigation brought against city, its city council and each member thereof and any officer or employee of city which results directly or indirectly from the wrongful or negligent actions of contractor’s officers, employees, agents or others employed by Contractor while engaged by contractor in the (performance of this agreement) construction of this project.

It is further agreed that the inclusion of more than one assured shall not operate to increase the limit of the company’s liability and that insurer waives any right on contribution with insurance which may be available to the city of Owosso.

The contractor, or any of their subcontractors, shall not commence work under this contract until they have attained the insurance required below, and shall keep such insurance in force during the entire life of this contract. All coverage shall be with insurance companies licensed and admitted to do business in the State of Michigan and acceptable to the city of Owosso. The requirements below should not be interpreted to limit the liability of the Contractor. All deductibles and SIR’s are the responsibility of the Contractor.

The Contractor shall procure and maintain the following insurance coverage:

1. **Worker’s Compensation Insurance** including Employers’ Liability Coverage, in accordance with all applicable statutes of the State of Michigan.
2. **Commercial General Liability Insurance** on an “Occurrence Basis” with limits of liability not less than \$3,000,000 per occurrence and aggregate. Coverage shall include the following extensions: (A) Contractual Liability; (B) Products and Completed Operations; (C) Independent Contractors Coverage; (D) Broad Form General Liability Extensions or equivalent, if not already included.
3. **Automobile Liability** including Michigan No-Fault Coverages, with limits of liability not less than \$3,000,000 per occurrence, combined single limit for Bodily Injury, and Property Damage. Coverage shall include all owned vehicles, all non-owned vehicles, and all hired vehicles.
4. **Additional Insured:** Commercial General Liability and Automobile Liability, as described above, shall include an endorsement stating the following shall be **Additional Insureds:** City of Owosso, all elected and appointed officials, all employees and volunteers, all boards, commissions, and/or authorities and board members, including employees and volunteers thereof. It is understood and agreed by naming City of Owosso as additional insured, coverage afforded is considered to be primary and any other insurance the city of Owosso may have in effect shall be considered secondary and/or excess.
5. **Cancellation Notice:** All policies, as described above, shall include an endorsement stating that it is understood and agreed that a Ten (10) days notice for non-payment of premium is required and a Thirty (30) days notice is required for Non-Renewal, Reduction, and/or Material Change, shall be sent to: City of Owosso, Bid Coordinator, 301 W. Main Street, Owosso, Michigan 48867.

6. **Proof of Insurance Coverage:** The Contractor shall provide the city of Owosso, at the time that the contracts are returned by him/her for execution, a Certificate of Insurance as well as the required endorsements. In lieu of required endorsements, if applicable, a copy of the policy sections where coverage is provided for additional insured and cancellation notice would be acceptable. Copies or certified copies of all policies mentioned above shall be furnished, if so requested.

If any of the above coverages expire during the term of this contract, the Contractor shall deliver renewal certificates and endorsements to the city of Owosso at least ten (10) days prior to the expiration date.

Please include a copy of insurance declaration verifying amounts of coverage. The verification of insurance is not an insurance policy and does not amend, extend or alter the coverage afforded by the policies listed herein. Notwithstanding any requirement, term, or condition of any contract or other document with respect to which this certificate or verification of insurance may be issued or may pertain, the insurance afforded by the policies described herein is subject to all the terms, exclusions and conditions of such policies.

DATE _____

BY _____
Authorized Insurance Agent

AGENCY _____

TITLE _____

ADDRESS _____

REQUIRED STANDARD CONTRACT LANGUAGE: CLEAN WATER STATE REVOLVING FUND AND DRINKING WATER REVOLVING FUND

- **Davis-Bacon/Prevailing Federal Wages, Including Labor Standards Provisions**
- **Disadvantaged Business Enterprise (DBE) Requirements***
- **Debarment/Suspension Certification***

*** Bidders should note these sections contain instructions regarding forms/information that must be completed/included with any submitted bid.**

Davis-Bacon/Prevailing Federal Wage Rates

P.L. 111-88 requires compliance with the Davis Bacon Act and adherence to the current U.S. Department of Labor Wage Decision. Attention is called to the fact that not less than the minimum salaries and wages as set forth in the Contract Documents (see Wage Decision included herein) must be paid on this project. The Wage Decision, including modifications, must be posted by the Contractor on the job site. A copy of the Federal Labor Standards Provisions is included and is hereby a part of this contract.

Replace this page with the appropriate Wage Decision and Modifications.

NOTE: The required/appropriate Wage Decision must be obtained from the United States Department of Labor (DOL) at:
<http://www.access.gpo.gov/davisbacon/index.html>

The Wage Decision that appears in the contract specifications must be that which was in effect on the date 10 days before bid opening.

The “Contracting Agency” or “Contracting Officer” for Davis-Bacon Wage Decision posters on jobsites is the loan applicant/bond issuer.

Questions regarding prevailing wage and labor standards provisions should be directed to the DOL.

"General Decision Number: MI20190044 10/25/2019

Superseded General Decision Number: MI20180044

State: Michigan

Construction Type: Heavy

Counties: Arenac, Branch, Gladwin, Hillsdale, Huron, Lenawee, Mecosta, Midland, Osceola, Shiawassee and Tuscola Counties in Michigan.

Heavy, Includes Water, Sewer Lines and Excavation (Excludes Hazardous Waste Removal; Coal, Oil, Gas, Duct and other similar Pipeline Construction)

Note: Under Executive Order (EO) 13658, an hourly minimum wage of \$10.60 for calendar year 2019 applies to all contracts subject to the Davis-Bacon Act for which the contract is awarded (and any solicitation was issued) on or after January 1, 2015. If this contract is covered by the EO, the contractor must pay all workers in any classification listed on this wage determination at least \$10.60 per hour (or the applicable wage rate listed on this wage determination, if it is higher) for all hours spent performing on the contract in calendar year 2019. If this contract is covered by the EO and a classification considered necessary for performance of work on the contract does not appear on this wage determination, the contractor must pay workers in that classification at least the wage rate determined through the conformance process set forth in 29 CFR 5.5(a)(1)(ii) (or the EO minimum wage rate, if it is higher than the conformed wage rate). The EO minimum wage rate will be adjusted annually. Please note that this EO applies to the above-mentioned types of contracts entered into by the federal government that are subject to the Davis-Bacon Act

itself, but it does not apply to contracts subject only to the Davis-Bacon Related Acts, including those set forth at 29 CFR 5.1(a)(2)-(60). Additional information on contractor requirements and worker protections under the EO is available at www.dol.gov/whd/govcontracts.

| Modification Number | Publication Date |
|---------------------|------------------|
| 0 | 01/04/2019 |
| 1 | 01/18/2019 |
| 2 | 02/08/2019 |
| 3 | 03/08/2019 |
| 4 | 04/12/2019 |
| 5 | 06/07/2019 |
| 6 | 07/05/2019 |
| 7 | 07/19/2019 |
| 8 | 07/26/2019 |
| 9 | 08/09/2019 |
| 10 | 08/30/2019 |
| 11 | 09/20/2019 |
| 12 | 09/27/2019 |
| 13 | 10/04/2019 |
| 14 | 10/25/2019 |

CARP0100-005 06/01/2019

MECOSTA & OSCEOLA COUNTIES

| | Rates | Fringes |
|---------------------------------|----------|---------|
| CARPENTER (Form Work Only)..... | \$ 23.01 | 19.84 |

CARP0525-008 06/01/2019

BRANCH & HILLSDALE COUNTIES

| | Rates | Fringes |
|---------------------------------|----------|---------|
| CARPENTER (Form Work Only)..... | \$ 23.66 | 20.19 |

CARP0706-014 06/01/2019

ARENAC, GLADWIN, HURON, MIDLAND & TUSCOLA COUNTIES

| | Rates | Fringes |
|---------------------------------|----------|---------|
| CARPENTER (Form Work Only)..... | \$ 26.61 | 21.54 |

 CARP0706-018 06/01/2019

SHIAWASSEE COUNTY

| | Rates | Fringes |
|---------------------------------|----------|---------|
| CARPENTER (Form Work Only)..... | \$ 27.21 | 21.54 |

 CARP1004-013 06/01/2019

LENAWEE COUNTY

| | Rates | Fringes |
|---------------------------------|----------|---------|
| CARPENTER (Form Work Only)..... | \$ 25.06 | 20.51 |

 ELEC0008-012 05/27/2019

HILLSDALE & LENAWE COUNTY

| | Rates | Fringes |
|------------------|----------|---------|
| ELECTRICIAN..... | \$ 40.45 | 22.05 |

 ELEC0058-008 07/01/2018

HURON COUNTY

| | Rates | Fringes |
|------------------|----------|---------|
| ELECTRICIAN..... | \$ 41.28 | 24.03 |

 ELEC0275-009 05/27/2019

MECOSTA COUNTY

| | Rates | Fringes |
|------------------|----------|---------|
| ELECTRICIAN..... | \$ 31.28 | 20.43 |

 ELEC0275-014 05/27/2019

OSCEOLA COUNTY (Townships of Richmond, Hersey, Evert & Orient)

| | Rates | Fringes |
|------------------|----------|---------|
| ELECTRICIAN..... | \$ 31.28 | 20.43 |

 ELEC0445-008 05/27/2019

BRANCH COUNTY

| | Rates | Fringes |
|------------------|----------|---------|
| ELECTRICIAN..... | \$ 33.05 | 20.70 |

 ELEC0498-012 06/01/2019

OSCEOLA COUNTY (does not include the townships of Evert, Hersey, Orient and Richmond)

| | Rates | Fringes |
|------------------|----------|---------|
| ELECTRICIAN..... | \$ 30.58 | 19.14 |

 ELEC0557-008 05/27/2019

MIDLAND (Townships of Ingersoll, Jasper, Mount Haley and Porter) & TUSCOLA (Townships of Almer, Arbela, Columbia, Dayton, Denmark, Elkland, Ellington, Elmwood, Fairgrove, Fremont, Gilford, Indianfields, Juniata, Kingston, Koylon, Novesta, Tuscola, Vassar, Watertown and Wells) COUNTIES

| | Rates | Fringes |
|------------------|----------|---------|
| ELECTRICIAN..... | \$ 33.75 | 22.23 |

 ELEC0665-018 05/27/2018

SHIAWASSEE COUNTY (Townships of Perry & Woodhull)

| | Rates | Fringes |
|------------------|----------|---------|
| ELECTRICIAN..... | \$ 35.20 | 23.34 |

 ELEC0692-017 05/27/2019

ARENAC & GLADWIN COUNTIES

| | Rates | Fringes |
|------------------|----------|---------|
| ELECTRICIAN..... | \$ 33.00 | 20.00 |

 ELEC0692-018 05/27/2019

MIDLAND (All townships except Mount Haley, Jasper, Porter & Ingersoll) & TUSCOLA (Townships of Wisner & Akron) COUNTIES

| | Rates | Fringes |
|------------------|----------|---------|
| ELECTRICIAN..... | \$ 33.00 | 20.00 |

 ELEC0948-008 05/26/2019

SHIAWASSEE (All townships except Perry & Woodhull) & TUSCOLA (Township of Millington) COUNTIES

| | Rates | Fringes |
|------------------|----------|---------|
| ELECTRICIAN..... | \$ 38.31 | 23.06 |

 ENGI0325-021 09/01/2018

POWER EQUIPMENT OPERATORS: Underground Construction (Including Sewer)

| | Rates | Fringes |
|--------------------------|----------|---------|
| POWER EQUIPMENT OPERATOR | | |
| GROUP 1..... | \$ 30.82 | 23.85 |
| GROUP 2..... | \$ 25.93 | 23.85 |
| GROUP 3..... | \$ 25.43 | 23.85 |
| GROUP 4..... | \$ 25.15 | 23.85 |

POWER EQUIPMENT OPERATOR CLASSIFICATIONS

GROUP 1: Backhoe/ Excavator, Boring Machine, Bulldozer, Crane, Scraper, Loader, Trencher (over 8 ft. digging capacity)

GROUP 2: Trencher (8-ft digging capacity and smaller)

GROUP 3: Boom Truck (non-swinging, non- powered type boom)

GROUP 4: Broom/ Sweeper, Fork Truck, Tractor

ENGI0326-014 06/01/2019

EXCLUDES UNDERGROUND CONSTRUCTION

AREA 1: BRANCH, HILLSDALE, MECOSTA & OSCEOLA COUNTIES

AREA 2: ARENAC, GLADWIN, HURON, MIDLAND, SHIAWASSEE & TUSCOLA COUNTIES

| | Rates | Fringes |
|---------------------|----------|---------|
| Operating Engineer: | | |
| AREA 1 | | |
| Group 1..... | \$ 39.58 | 24.35 |

| | | |
|--------------|----------|-------|
| Group 2..... | \$ 36.28 | 24.35 |
| Group 3..... | \$ 33.63 | 24.35 |
| Group 4..... | \$ 31.92 | 24.35 |
| Group 5..... | \$ 23.58 | 24.35 |

Operating Engineers:

AREA 2

| | | |
|--------------|----------|-------|
| Group 1..... | \$ 39.58 | 24.35 |
| Group 2..... | \$ 36.28 | 24.35 |
| Group 3..... | \$ 33.63 | 24.35 |
| Group 4..... | \$ 31.92 | 24.35 |
| Group 5..... | \$ 23.58 | 24.35 |

FOOTNOTES:

Crane operator with main boom and jib 300' or longer: \$1.50 per hour above the group 1 rate.

Crane operator with main boom and jib 400' or longer: \$3.00 per hour above the group 1 rate.

PAID HOLIDAYS: New Year's Day, Memorial Day, Fourth of July, Labor Day, Thanksgiving Day and Christmas Day.

POWER EQUIPMENT OPERATOR CLASSIFICATIONS

GROUP 1: Crane operator with main boom and jib 400', 300', or 220' or longer.

GROUP 2: Crane operator with main boom and jib 140' or longer, tower crane, gantry crane, whirley derrick

GROUP 3: Backhoe/Excavator; Bulldozer; Compactor; Crane; Scraper; Loader

GROUP 4: Boom truck (non-swinging)

GROUP 5: Oiler

ENGI0326-024 06/01/2019

EXCLUDES UNDERGROUND CONSTRUCTION

LENAWEE COUNTY

| | Rates | Fringes |
|---------------------------|----------|---------|
| OPERATOR: Power Equipment | | |
| GROUP 1..... | \$ 41.89 | 24.45 |
| GROUP 2..... | \$ 40.39 | 24.45 |
| GROUP 3..... | \$ 38.89 | 24.45 |
| GROUP 4..... | \$ 38.59 | 24.45 |
| GROUP 5..... | \$ 37.77 | 24.45 |
| GROUP 6..... | \$ 36.91 | 24.45 |
| GROUP 7..... | \$ 35.94 | 24.45 |
| GROUP 8..... | \$ 25.89 | 24.45 |

FOOTNOTES: Tower cranes: to be paid the crane operator rate determined by the combined length of the mast and the boom.

POWER EQUIPMENT OPERATOR CLASSIFICATIONS

GROUP 1: Crane with boom & jib or leads 400' or longer

GROUP 2: Crane with boom & jib or leads 300' or longer

GROUP 3: Crane with boom & jib or leads 220' or longer

GROUP 4: Crane with boom & jib or leads 140' or longer

GROUP 5: Crane with boom & jib or leads 120' or longer

GROUP 6: Regular crane operator

GROUP 7: Backhoe/Excavator, Bulldozer, Compactor, Scraper, Loader

GROUP 8: Oiler

IRON0025-007 06/01/2018

ARENAC, GLADWIN, HURON, MIDLAND, SHIAWASSEE & TUSCOLA COUNTIES

| | Rates | Fringes |
|------------------|----------|---------|
| IRONWORKER | | |
| Reinforcing..... | \$ 29.48 | 27.74 |
| Structural..... | \$ 35.52 | 28.65 |

* IRON0055-011 07/01/2019

LENAWEE COUNTY

| | Rates | Fringes |
|----------------------------|----------|---------|
| IRONWORKER, STRUCTURAL AND | | |
| REINFORCING..... | \$ 30.38 | 24.40 |

IRON0340-012 06/19/2017

BRANCH, HILLSDALE, MECOSTA & OSCEOLA COUNTIES

| | Rates | Fringes |
|----------------------------|----------|---------|
| IRONWORKER, STRUCTURAL AND | | |
| REINFORCING..... | \$ 24.43 | 24.67 |

LABO0334-008 09/01/2018

SCOPE OF WORK:

OPEN CUT CONSTRUCTION: Excavation of earth and sewer, utilities, and improvements, including underground piping/conduit (including inspection, cleaning, restoration, and relining)

ARENAC, BRANCH, GLADWIN, HURON, MECOSTA, MIDLAND, OSCEOLA, TUSCOLA

| | Rates | Fringes |
|--|-------|---------|
|--|-------|---------|

LABORER

| | |
|------------------------------------|-------|
| (1) Common or General.....\$ 20.97 | 12.85 |
| (4) Grade Checker.....\$ 21.28 | 12.85 |

LAB00334-019 09/01/2018

SCOPE OF WORK:

OPEN CUT CONSTRUCTION: Excavation of earth and sewer, utilities, and improvements, including underground piping/conduit (including inspection, cleaning, restoration, and relining)

HILLSDALE, LENAWEE, SHIAWASSEE

| | Rates | Fringes |
|------------------------------------|-------|---------|
| LABORER | | |
| (1) Common or General.....\$ 20.97 | | 12.85 |
| (4) Grade Checker.....\$ 21.28 | | 12.85 |

LAB00355-007 06/01/2018

EXCLUDES OPEN CUT CONSTRUCTION

BRANCH COUNTY

| | Rates | Fringes |
|--------------------------------|-------|---------|
| LABORER | | |
| Common or General.....\$ 23.02 | | 12.85 |

LAB00355-015 06/01/2018

EXCLUDES OPEN CUT CONSTRUCTION

MECOSTA & OSCEOLA COUNTIES

| | Rates | Fringes |
|--------------------------------|-------|---------|
| LABORER | | |
| Common or General.....\$ 22.48 | | 12.85 |

LABO0499-014 06/01/2019

EXCLUDES OPEN CUT CONSTRUCTION

HILLSDALE & LENAWEЕ COUNTIES

| | Rates | Fringes |
|------------------------|----------|---------|
| LABORER | | |
| Common or General..... | \$ 26.21 | 12.90 |

LABO1075-011 06/01/2019

EXCLUDES OPEN CUT CONSTRUCTION

SHIAWASSEE COUNTY

| | Rates | Fringes |
|------------------------|----------|---------|
| LABORER | | |
| Common or General..... | \$ 23.00 | 13.66 |

LABO1098-022 07/01/2019

EXCLUDES OPEN CUT CONSTRUCTION

ARENAC, GLADWIN, HURON, MIDLAND & TUSCOLA COUNTIES

| | Rates | Fringes |
|------------------------|----------|---------|
| LABORER | | |
| Common or General..... | \$ 20.12 | 12.90 |

PLAS0016-009 04/01/2014

MECOSTA & OSCEOLA COUNTIES

| | Rates | Fringes |
|-----------------------------------|----------|---------|
| CEMENT MASON/CONCRETE FINISHER... | \$ 22.02 | 12.38 |

PLAS0016-021 04/01/2014

SHIAWASSEE COUNTY

| | Rates | Fringes |
|-----------------------------------|----------|---------|
| CEMENT MASON/CONCRETE FINISHER... | \$ 25.58 | 12.88 |

PLAS0016-023 04/01/2014

BRANCH COUNTY

| | Rates | Fringes |
|-----------------------------------|----------|---------|
| CEMENT MASON/CONCRETE FINISHER... | \$ 24.63 | 12.88 |

PLAS0016-031 04/01/2014

ARENAC, GLADWIN, HURON, MIDLAND & TUSCOLA COUNTIES

| | Rates | Fringes |
|-----------------------------------|----------|---------|
| CEMENT MASON/CONCRETE FINISHER... | \$ 25.47 | 12.38 |

PLAS0886-013 08/01/2011

HILLSDALE & LENAWEЕ COUNTIES

| | Rates | Fringes |
|-----------------------------------|----------|---------|
| CEMENT MASON/CONCRETE FINISHER... | \$ 27.19 | 16.00 |

PLUM0085-017 05/07/2019

ARENAC, GLADWIN, HURON (West of M-53), MIDLAND & TUSCOLA
COUNTIES

| Rates | Fringes |
|-------|---------|
|-------|---------|

PLUMBER/PIPEFITTER.....\$ 36.35 21.07

PLUM0098-008 06/01/2019

HURON COUNTY (East of M-53)

Rates Fringes

PLUMBER.....\$ 35.77 35.13

PLUM0174-015 07/01/2019

MECOSTA & OSCEOLA COUNTIES

Rates Fringes

PLUMBER/PIPEFITTER.....\$ 35.26 22.52

PLUM0190-012 06/01/2019

LENAWEE COUNTY (Townships of Clinton, Macon & Tecumseh)

Rates Fringes

PLUMBER/PIPEFITTER.....\$ 42.26 23.24

PLUM0333-021 06/01/2019

BRANCH & HILLSDALE COUNTIES

Rates Fringes

PLUMBER/PIPEFITTER.....\$ 38.19 22.33

PLUM0333-022 06/01/2019

LENAWEE COUNTY (Remainder of County)

Rates Fringes

PLUMBER/PIPEFITTER.....\$ 38.19 22.33

PLUM0370-007 06/01/2018

SHIAWASSEE COUNTY

| | Rates | Fringes |
|-------------------------|----------|---------|
| PLUMBER/PIPEFITTER..... | \$ 37.81 | 20.60 |

PLUM0636-008 06/05/2017

HURON COUNTY (East of M-53)

| | Rates | Fringes |
|-----------------|----------|---------|
| PIPEFITTER..... | \$ 40.41 | 29.35 |

TEAM0007-010 06/01/2019

| | Rates | Fringes |
|------------------------------|----------|-----------|
| TRUCK DRIVER | | |
| Lowboy/Semi-Trailer Truck... | \$ 27.40 | .50 + a+b |

FOOTNOTE:

- a. \$455.10 per week.
- b. \$68.70 daily.

SUMI2010-042 11/09/2010

| | Rates | Fringes |
|---|----------|---------|
| CARPENTER, Excludes Form Work.... | \$ 23.97 | 6.29 |
| LABORER: Landscape..... | \$ 10.89 | 1.74 |
| LABORER: Mason Tender - Cement/Concrete..... | \$ 15.97 | 3.51 |
| LABORER: Pipelayer..... | \$ 15.28 | 3.99 |

OPERATOR: Bobcat/Skid

Steer/Skid Loader.....\$ 12.98 6.12

OPERATOR: Grader/Blade.....\$ 15.50 3.62

OPERATOR: Roller.....\$ 13.74 7.93

TRUCK DRIVER: Dump Truck.....\$ 14.06 1.25

WELDERS - Receive rate prescribed for craft performing operation to which welding is incidental.

=====
Note: Executive Order (EO) 13706, Establishing Paid Sick Leave for Federal Contractors applies to all contracts subject to the Davis-Bacon Act for which the contract is awarded (and any solicitation was issued) on or after January 1, 2017. If this contract is covered by the EO, the contractor must provide employees with 1 hour of paid sick leave for every 30 hours they work, up to 56 hours of paid sick leave each year. Employees must be permitted to use paid sick leave for their own illness, injury or other health-related needs, including preventive care; to assist a family member (or person who is like family to the employee) who is ill, injured, or has other health-related needs, including preventive care; or for reasons resulting from, or to assist a family member (or person who is like family to the employee) who is a victim of, domestic violence, sexual assault, or stalking. Additional information on contractor requirements and worker protections under the EO is available at www.dol.gov/whd/govcontracts.

Unlisted classifications needed for work not included within the scope of the classifications listed may be added after award only as provided in the labor standards contract clauses (29CFR 5.5 (a) (1) (ii)).

The body of each wage determination lists the classification and wage rates that have been found to be prevailing for the cited type(s) of construction in the area covered by the wage determination. The classifications are listed in alphabetical order of ""identifiers"" that indicate whether the particular rate is a union rate (current union negotiated rate for local), a survey rate (weighted average rate) or a union average rate (weighted union average rate).

Union Rate Identifiers

A four letter classification abbreviation identifier enclosed in dotted lines beginning with characters other than ""SU"" or ""UAVG"" denotes that the union classification and rate were prevailing for that classification in the survey. Example: PLUM0198-005 07/01/2014. PLUM is an abbreviation identifier of the union which prevailed in the survey for this classification, which in this example would be Plumbers. 0198 indicates the local union number or district council number where applicable, i.e., Plumbers Local 0198. The next number, 005 in the example, is an internal number used in processing the wage determination. 07/01/2014 is the effective date of the most current negotiated rate, which in this example is July 1, 2014.

Union prevailing wage rates are updated to reflect all rate changes in the collective bargaining agreement (CBA) governing this classification and rate.

Survey Rate Identifiers

Classifications listed under the ""SU"" identifier indicate that no one rate prevailed for this classification in the survey and the published rate is derived by computing a weighted average rate based on all the rates reported in the survey for that classification. As this weighted average rate includes all rates reported in the survey, it may include both union and non-union rates. Example: SULA2012-007 5/13/2014. SU indicates the rates are survey rates based on a weighted average calculation of rates and are not majority rates. LA indicates

the State of Louisiana. 2012 is the year of survey on which these classifications and rates are based. The next number, 007 in the example, is an internal number used in producing the wage determination. 5/13/2014 indicates the survey completion date for the classifications and rates under that identifier.

Survey wage rates are not updated and remain in effect until a new survey is conducted.

Union Average Rate Identifiers

Classification(s) listed under the UAVG identifier indicate that no single majority rate prevailed for those classifications; however, 100% of the data reported for the classifications was union data. EXAMPLE: UAVG-OH-0010 08/29/2014. UAVG indicates that the rate is a weighted union average rate. OH indicates the state. The next number, 0010 in the example, is an internal number used in producing the wage determination. 08/29/2014 indicates the survey completion date for the classifications and rates under that identifier.

A UAVG rate will be updated once a year, usually in January of each year, to reflect a weighted average of the current negotiated/CBA rate of the union locals from which the rate is based.

WAGE DETERMINATION APPEALS PROCESS

1.) Has there been an initial decision in the matter? This can be:

- * an existing published wage determination
- * a survey underlying a wage determination
- * a Wage and Hour Division letter setting forth a position on a wage determination matter
- * a conformance (additional classification and rate) ruling

On survey related matters, initial contact, including requests for summaries of surveys, should be with the Wage and Hour Regional Office for the area in which the survey was conducted because those Regional Offices have responsibility for the Davis-Bacon survey program. If the response from this initial contact is not satisfactory, then the process described in 2.) and 3.) should be followed.

With regard to any other matter not yet ripe for the formal process described here, initial contact should be with the Branch of Construction Wage Determinations. Write to:

Branch of Construction Wage Determinations
Wage and Hour Division
U.S. Department of Labor
200 Constitution Avenue, N.W.
Washington, DC 20210

2.) If the answer to the question in 1.) is yes, then an interested party (those affected by the action) can request review and reconsideration from the Wage and Hour Administrator (See 29 CFR Part 1.8 and 29 CFR Part 7). Write to:

Wage and Hour Administrator
U.S. Department of Labor
200 Constitution Avenue, N.W.
Washington, DC 20210

The request should be accompanied by a full statement of the interested party's position and by any information (wage payment data, project description, area practice material, etc.) that the requestor considers relevant to the issue.

3.) If the decision of the Administrator is not favorable, an interested party may appeal directly to the Administrative Review Board (formerly the Wage Appeals Board). Write to:

Administrative Review Board
U.S. Department of Labor
200 Constitution Avenue, N.W.
Washington, DC 20210

4.) All decisions by the Administrative Review Board are final.

=====

END OF GENERAL DECISION"

29 CFR Part 5 – Labor Standards Provisions for Federally Assisted Projects

§ 5.5 Contract provisions and related matters.

(a) The Agency head shall cause or require the contracting officer to insert in full in any contract in excess of \$2,000 which is entered into for the actual construction, alteration and/or repair, including painting and decorating, of a public building or public work, or building or work financed in whole or in part from Federal funds or in accordance with guarantees of a Federal agency or financed from funds obtained by pledge of any contract of a Federal agency to make a loan, grant or annual contribution (except where a different meaning is expressly indicated), and which is subject to the labor standards provisions of any of the acts listed in Sec. 5.1, the following clauses (or any modifications thereof to meet the particular needs of the agency, *Provided*, That such modifications are first approved by the Department of Labor):

(1) *Minimum wages.* (i) All laborers and mechanics employed or working upon the site of the work (or under the United States Housing Act of 1937 or under the Housing Act of 1949 in the construction or development of the project), will be paid unconditionally and not less often than once a week, and without subsequent deduction or rebate on any account (except such payroll deductions as are permitted by regulations issued by the Secretary of Labor under the Copeland Act (29 CFR part 3)), the full amount of wages and bona fide fringe benefits (or cash equivalents thereof) due at time of payment computed at rates not less than those contained in the wage determination of the Secretary of Labor which is attached hereto and made a part hereof, regardless of any contractual relationship which may be alleged to exist between the contractor and such laborers and mechanics.

Contributions made or costs reasonably anticipated for bona fide fringe benefits under section 1(b)(2) of the Davis-Bacon Act on behalf of laborers or mechanics are considered wages paid to such laborers or mechanics, subject to the provisions of paragraph (a)(1)(iv) of this section; also, regular contributions made or costs incurred for more than a weekly period (but not less often than quarterly) under plans, funds, or programs which cover the particular weekly period, are deemed to be constructively made or incurred during such weekly period. Such laborers and mechanics shall be paid the appropriate wage rate and fringe benefits on the wage determination for the classification of work actually performed, without regard to skill, except as provided in Sec. 5.5(a)(4). Laborers or mechanics performing work in more than one classification may be compensated at the rate specified for each classification for the time actually worked therein: *Provided*, That the employer's payroll records accurately set forth the time spent in each classification in which work is performed. The wage determination (including any additional classification and wage rates conformed under paragraph (a)(1)(ii) of this section) and the Davis-Bacon poster (WH-1321) shall be posted at all times by the contractor and its subcontractors at the site of the work in a prominent and accessible place where it can be easily seen by the workers.

(ii)(A) The contracting officer shall require that any class of laborers or mechanics, including helpers, which is not listed in the wage determination and which is to be employed under the contract shall be classified in conformance with the wage determination. The contracting officer shall approve an additional classification and wage rate and fringe benefits therefore only when the following criteria have been met:

(1) The work to be performed by the classification requested is not performed by a classification in the wage determination; and

(2) The classification is utilized in the area by the construction industry; and

(3) The proposed wage rate, including any bona fide fringe benefits, bears a reasonable relationship to the wage rates contained in the wage determination.

(B) If the contractor and the laborers and mechanics to be employed in the classification (if known), or their representatives, and the contracting officer agree on the classification and wage rate (including the amount designated for fringe benefits where appropriate), a report of the action taken shall be sent by the contracting officer to the Administrator of the Wage and Hour Division, Employment Standards Administration, U.S. Department of Labor, Washington, DC 20210. The Administrator, or an authorized representative, will approve, modify, or disapprove every additional classification action within 30 days of receipt and so advise the contracting officer or will notify the contracting officer within the 30-day period that additional time is necessary.

(C) In the event the contractor, the laborers or mechanics to be employed in the classification or their representatives, and the contracting officer do not agree on the proposed classification and wage rate (including the amount designated for fringe benefits, where appropriate), the contracting officer shall refer the questions, including the views of all interested parties and the recommendation of the contracting officer, to the Administrator for determination. The Administrator, or an authorized representative, will issue a determination within 30 days of receipt and so advise the contracting officer or will notify the contracting officer within the 30-day period that additional time is necessary.

(D) The wage rate (including fringe benefits where appropriate) determined pursuant to paragraphs (a)(1)(ii) (B) or (C) of this section, shall be paid to all workers performing work in the classification under this contract from the first day on which work is performed in the classification.

(iii) Whenever the minimum wage rate prescribed in the contract for a class of laborers or mechanics includes a fringe benefit which is not expressed as an hourly rate, the contractor shall either pay the benefit as stated in the wage determination or shall pay another bona fide fringe benefit or an hourly cash equivalent thereof.

(iv) If the contractor does not make payments to a trustee or other third person, the contractor may consider as part of the wages of any laborer or mechanic the amount of any costs reasonably anticipated in providing bona fide fringe benefits under a plan or program, Provided, That the Secretary of Labor has found, upon the written request of the contractor, that the applicable standards of the Davis-Bacon Act have been met. The Secretary of Labor may require the contractor to set aside in a separate account assets for the meeting of obligations under the plan or program.

(2) *Withholding.* The (write in name of Federal Agency or the loan or grant recipient) shall upon its own action or upon written request of an authorized representative of the Department of Labor withhold or cause to be withheld from the contractor under this contract or any other Federal contract with the same prime contractor, or any other federally-assisted contract subject to Davis-Bacon prevailing wage requirements, which is held by the same prime contractor, so much of the accrued payments or advances as may be considered necessary to pay laborers and mechanics, including apprentices, trainees, and helpers, employed by the contractor or any subcontractor the full amount of wages required by the contract. In the event of failure to pay any laborer or mechanic, including any apprentice, trainee, or helper, employed or working on the site of the work (or under the United States Housing Act of 1937 or under the Housing Act of

1949 in the construction or development of the project), all or part of the wages required by the contract, the (Agency) may, after written notice to the contractor, sponsor, applicant, or owner, take such action as may be necessary to cause the suspension of any further payment, advance, or guarantee of funds until such violations have ceased.

(3) *Payrolls and basic records.* (i) Payrolls and basic records relating thereto shall be maintained by the contractor during the course of the work and preserved for a period of three years thereafter for all laborers and mechanics working at the site of the work (or under the United States Housing Act of 1937, or under the Housing Act of 1949, in the construction or development of the project). Such records shall contain the name, address, and social security number of each such worker, his or her correct classification, hourly rates of wages paid (including rates of contributions or costs anticipated for bona fide fringe benefits or cash equivalents thereof of the types described in section 1(b)(2)(B) of the Davis-Bacon Act), daily and weekly number of hours worked, deductions made and actual wages paid. Whenever the Secretary of Labor has found under 29 CFR 5.5(a)(1)(iv) that the wages of any laborer or mechanic include the amount of any costs reasonably anticipated in providing benefits under a plan or program described in section 1(b)(2)(B) of the Davis-Bacon Act, the contractor shall maintain records which show that the commitment to provide such benefits is enforceable, that the plan or program is financially responsible, and that the plan or program has been communicated in writing to the laborers or mechanics affected, and records which show the costs anticipated or the actual cost incurred in providing such benefits. Contractors employing apprentices or trainees under approved programs shall maintain written evidence of the registration of apprenticeship programs and certification of trainee programs, the registration of the apprentices and trainees, and the ratios and wage rates prescribed in the applicable programs.

(ii)(A) The contractor shall submit weekly for each week in which any contract work is performed a copy of all payrolls to the (write in name of appropriate federal agency) if the agency is a party to the contract, but if the agency is not such a party, the contractor will submit the payrolls to the applicant, sponsor, or owner, as the case may be, for transmission to the (write in name of agency). The payrolls submitted shall set out accurately and completely all of the information required to be maintained under 29 CFR 5.5(a)(3)(i), except that full social security numbers and home addresses shall not be included on weekly transmittals. Instead the payrolls shall only need to include an individually identifying number for each employee (e.g., the last four digits of the employee's social security number). The required weekly payroll information may be submitted in any form desired. Optional Form WH-347 is available for this purpose from the Wage and Hour Division Web site at <http://www.dol.gov/whd/forms/wh347.pdf> or its successor site. The prime contractor is responsible for the submission of copies of payrolls by all subcontractors. Contractors and subcontractors shall maintain the full social security number and current address of each covered worker, and shall provide them upon request to the (write in name of appropriate federal agency) if the agency is a party to the contract, but if the agency is not such a party, the contractor will submit them to the applicant, sponsor, or owner, as the case may be, for transmission to the (write in name of agency), the contractor, or the Wage and Hour Division of the Department of Labor for purposes of an investigation or audit of compliance with prevailing wage requirements. It is not a violation of this section for a prime contractor to require a subcontractor to provide addresses and social security numbers to the prime contractor for its own records, without weekly submission to the sponsoring government agency (or the applicant, sponsor, or owner).

(B) Each payroll submitted shall be accompanied by a "Statement of Compliance," signed by the contractor or subcontractor or his or her agent who pays or supervises the payment of the persons employed under the contract and shall certify the following:

(1) That the payroll for the payroll period contains the information required to be provided under Sec. 5.5 (a)(3)(ii) of Regulations, 29 CFR part 5, the appropriate information is being maintained under Sec. 5.5 (a)(3)(i) of Regulations, 29 CFR part 5, and that such information is correct and complete;

(2) That each laborer or mechanic (including each helper, apprentice, and trainee) employed on the contract during the payroll period has been paid the full weekly wages earned, without rebate, either directly or indirectly, and that no deductions have been made either directly or indirectly from the full wages earned, other than permissible deductions as set forth in Regulations, 29 CFR part 3;

(3) That each laborer or mechanic has been paid not less than the applicable wage rates and fringe benefits or cash equivalents for the classification of work performed, as specified in the applicable wage determination incorporated into the contract.

(C) The weekly submission of a properly executed certification set forth on the reverse side of Optional Form WH-347 shall satisfy the requirement for submission of the "Statement of Compliance" required by paragraph (a)(3)(ii)(B) of this section.

(D) The falsification of any of the above certifications may subject the contractor or subcontractor to civil or criminal prosecution under section 1001 of title 18 and section 231 of title 31 of the United States Code.

(iii) The contractor or subcontractor shall make the records required under paragraph (a)(3)(i) of this section available for inspection, copying, or transcription by authorized representatives of the (write the name of the agency) or the Department of Labor, and shall permit such representatives to interview employees during working hours on the job. If the contractor or subcontractor fails to submit the required records or to make them available, the Federal agency may, after written notice to the contractor, sponsor, applicant, or owner, take such action as may be necessary to cause the suspension of any further payment, advance, or guarantee of funds. Furthermore, failure to submit the required records upon request or to make such records available may be grounds for debarment action pursuant to 29 CFR 5.12.

(4) *Apprentices and trainees--(i) Apprentices.* Apprentices will be permitted to work at less than the predetermined rate for the work they performed when they are employed pursuant to and individually registered in a bona fide apprenticeship program registered with the U.S. Department of Labor, Employment and Training Administration, Office of Apprenticeship Training, Employer and Labor Services, or with a State Apprenticeship Agency recognized by the Office, or if a person is employed in his or her first 90 days of probationary employment as an apprentice in such an apprenticeship program, who is not individually registered in the program, but who has been certified by the Office of Apprenticeship Training, Employer and Labor Services or a State Apprenticeship Agency (where appropriate) to be eligible for probationary employment as an apprentice. The allowable ratio of apprentices to journeymen on the job site in any craft classification shall not be greater than the ratio permitted to the contractor as to the entire work force under the registered program. Any worker listed on a payroll at an apprentice wage rate, who is not registered or otherwise employed as stated above, shall be paid not less than the applicable wage rate on the wage determination for the classification of work actually performed. In addition, any apprentice performing work on the job site in excess of the ratio permitted under the registered program shall be paid not less than the applicable wage rate on the wage determination for the work actually performed. Where a contractor is performing construction on a project in a locality other than that in which its

program is registered, the ratios and wage rates (expressed in percentages of the journeyman's hourly rate) specified in the contractor's or subcontractor's registered program shall be observed. Every apprentice must be paid at not less than the rate specified in the registered program for the apprentice's level of progress, expressed as a percentage of the journeymen hourly rate specified in the applicable wage determination. Apprentices shall be paid fringe benefits in accordance with the provisions of the apprenticeship program. If the apprenticeship program does not specify fringe benefits, apprentices must be paid the full amount of fringe benefits listed on the wage determination for the applicable classification. If the Administrator determines that a different practice prevails for the applicable apprentice classification, fringes shall be paid in accordance with that determination. In the event the Office of Apprenticeship Training, Employer and Labor Services, or a State Apprenticeship Agency recognized by the Office, withdraws approval of an apprenticeship program, the contractor will no longer be permitted to utilize apprentices at less than the applicable predetermined rate for the work performed until an acceptable program is approved.

(ii) *Trainees.* Except as provided in 29 CFR 5.16, trainees will not be permitted to work at less than the predetermined rate for the work performed unless they are employed pursuant to and individually registered in a program which has received prior approval, evidenced by formal certification by the U.S. Department of Labor, Employment and Training Administration. The ratio of trainees to journeymen on the job site shall not be greater than permitted under the plan approved by the Employment and Training Administration. Every trainee must be paid at not less than the rate specified in the approved program for the trainee's level of progress, expressed as a percentage of the journeyman hourly rate specified in the applicable wage determination. Trainees shall be paid fringe benefits in accordance with the provisions of the trainee program. If the trainee program does not mention fringe benefits, trainees shall be paid the full amount of fringe benefits listed on the wage determination unless the Administrator of the Wage and Hour Division determines that there is an apprenticeship program associated with the corresponding journeyman wage rate on the wage determination which provides for less than full fringe benefits for apprentices. Any employee listed on the payroll at a trainee rate who is not registered and participating in a training plan approved by the Employment and Training Administration shall be paid not less than the applicable wage rate on the wage determination for the classification of work actually performed. In addition, any trainee performing work on the job site in excess of the ratio permitted under the registered program shall be paid not less than the applicable wage rate on the wage determination for the work actually performed. In the event the Employment and Training Administration withdraws approval of a training program, the contractor will no longer be permitted to utilize trainees at less than the applicable predetermined rate for the work performed until an acceptable program is approved.

(iii) *Equal employment opportunity.* The utilization of apprentices, trainees and journeymen under this part shall be in conformity with the equal employment opportunity requirements of Executive Order 11246, as amended, and 29 CFR part 30.

(5) *Compliance with Copeland Act requirements.* The contractor shall comply with the requirements of 29 CFR part 3, which are incorporated by reference in this contract.

(6) *Subcontracts.* The contractor or subcontractor shall insert in any subcontracts the clauses contained in 29 CFR 5.5(a)(1) through (10) and such other clauses as the (write in the name of the Federal agency) may by appropriate instructions require, and also a clause requiring the subcontractors to include these clauses in any lower tier subcontracts. The prime contractor shall be responsible for the compliance by any subcontractor or lower tier subcontractor with all the contract clauses in 29 CFR 5.5.

(7) *Contract termination: debarment.* A breach of the contract clauses in 29 CFR 5.5 may be grounds for termination of the contract, and for debarment as a contractor and a subcontractor as provided in 29 CFR 5.12.

(8) *Compliance with Davis-Bacon and Related Act requirements.* All rulings and interpretations of the Davis-Bacon and Related Acts contained in 29 CFR parts 1, 3, and 5 are herein incorporated by reference in this contract.

(9) *Disputes concerning labor standards.* Disputes arising out of the labor standards provisions of this contract shall not be subject to the general disputes clause of this contract. Such disputes shall be resolved in accordance with the procedures of the Department of Labor set forth in 29 CFR parts 5, 6, and 7. Disputes within the meaning of this clause include disputes between the contractor (or any of its subcontractors) and the contracting agency, the U.S. Department of Labor, or the employees or their representatives.

(10) *Certification of eligibility.* (i) By entering into this contract, the contractor certifies that neither it (nor he or she) nor any person or firm who has an interest in the contractor's firm is a person or firm ineligible to be awarded Government contracts by virtue of section 3(a) of the Davis-Bacon Act or 29 CFR 5.12(a)(1).

(ii) No part of this contract shall be subcontracted to any person or firm ineligible for award of a Government contract by virtue of section 3(a) of the Davis-Bacon Act or 29 CFR 5.12(a)(1).

(iii) The penalty for making false statements is prescribed in the U.S. Criminal Code, 18 U.S.C. 1001.

(b) *Contract Work Hours and Safety Standards Act.* The Agency Head shall cause or require the contracting officer to insert the following clauses set forth in paragraphs (b)(1), (2), (3), and (4) of this section in full in any contract in an amount in excess of \$100,000 and subject to the overtime provisions of the Contract Work Hours and Safety Standards Act. These clauses shall be inserted in addition to the clauses required by Sec. 5.5(a) or 4.6 of part 4 of this title. As used in this paragraph, the terms laborers and mechanics include watchmen and guards.

(1) *Overtime requirements.* No contractor or subcontractor contracting for any part of the contract work which may require or involve the employment of laborers or mechanics shall require or permit any such laborer or mechanic in any workweek in which he or she is employed on such work to work in excess of forty hours in such workweek unless such laborer or mechanic receives compensation at a rate not less than one and one-half times the basic rate of pay for all hours worked in excess of forty hours in such workweek.

(2) *Violation; liability for unpaid wages; liquidated damages.* In the event of any violation of the clause set forth in paragraph (b)(1) of this section the contractor and any subcontractor responsible there for shall be liable for the unpaid wages. In addition, such contractor and subcontractor shall be liable to the United States (in the case of work done under contract for the District of Columbia or a territory, to such District or to such territory), for liquidated damages. Such liquidated damages shall be computed with respect to each individual laborer or mechanic, including watchmen and guards, employed in violation of the clause set forth in paragraph (b)(1) of this section, in the sum of \$10 for each calendar day on which such individual was required or permitted to work in excess of the standard workweek of forty hours without payment of the overtime wages required by the clause set forth in paragraph (b)(1) of this section.

(3) *Withholding for unpaid wages and liquidated damages.* The (write in the name of the Federal agency or the loan or grant recipient) shall upon its own action or upon written request of an authorized representative of the Department of Labor withhold or cause to be withheld, from any moneys payable on account of work performed by the contractor or subcontractor under any such contract or any other Federal contract with the same prime contractor, or any other federally-assisted contract subject to the Contract Work Hours and Safety Standards Act, which is held by the same prime contractor, such sums as may be determined to be necessary to satisfy any liabilities of such contractor or subcontractor for unpaid wages and liquidated damages as provided in the clause set forth in paragraph (b)(2) of this section.

(4) *Subcontracts.* The contractor or subcontractor shall insert in any subcontracts the clauses set forth in paragraph (b)(1) through (4) of this section and also a clause requiring the subcontractors to include these clauses in any lower tier subcontracts. The prime contractor shall be responsible for compliance by any subcontractor or lower tier subcontractor with the clauses set forth in paragraphs (b)(1) through (4) of this section.

(c) In addition to the clauses contained in paragraph (b), in any contract subject only to the Contract Work Hours and Safety Standards Act and not to any of the other statutes cited in Sec. 5.1, the Agency Head shall cause or require the contracting officer to insert a clause requiring that the contractor or subcontractor shall maintain payrolls and basic payroll records during the course of the work and shall preserve them for a period of three years from the completion of the contract for all laborers and mechanics, including guards and watchmen, working on the contract. Such records shall contain the name and address of each such employee, social security number, correct classifications, hourly rates of wages paid, daily and weekly number of hours worked, deductions made, and actual wages paid. Further, the Agency Head shall cause or require the contracting officer to insert in any such contract a clause providing that the records to be maintained under this paragraph shall be made available by the contractor or subcontractor for inspection, copying, or transcription by authorized representatives of the (write the name of agency) and the Department of Labor, and the contractor or subcontractor will permit such representatives to interview employees during working hours on the job.

Disadvantaged Business Enterprises (DBE)

Prime contractors bidding on this project must follow, document, and maintain documentation of their Good Faith Efforts, as listed below, to ensure that Disadvantaged Business Enterprises (DBEs) have the opportunity to participate in the project by increasing DBE awareness of procurement efforts and outreach. Bidders must make the following Good Faith Efforts for any work that will be subcontracted.

1. Ensure DBEs are made aware of contracting opportunities to the fullest extent practicable through outreach and recruitment activities. Place DBEs on solicitation lists and solicit DBEs whenever they are potential sources.
2. Make information on forthcoming opportunities available to DBEs. Arrange time-frames for contracts and establish delivery schedules, where the requirements permit, in a way that encourages and facilitates participation by DBEs in the competitive process. Whenever possible, post solicitation for bids or proposals for a minimum of 30 calendar days before the bid or proposal closing date. The DBEs should be given a minimum of 5 days to respond to the posting.
3. Consider in the contracting process whether firms competing for large contracts can be subcontracted with DBEs. Divide total requirements, when economically feasible, into smaller tasks or quantities to permit maximum participation by DBEs in the competitive process.
4. Encourage contracting with a consortium of DBEs when a contract is too large for one DBE firm to handle individually.
5. Use the services and assistance of the Small Business Administration and the Minority Business Development Agency of the U.S. Department of Commerce.

Subsequent to compliance with the Good Faith Efforts, the following conditions also apply under the DBE requirements. Completed Good Faith Efforts Worksheets (Attachment 1), along with the required supporting documentation outlined in the instructions, must be submitted with your bid proposal. EPA form 6100-2 must also be provided at the pre-bid meeting. A copy of this form is available on the Forms and Guidance page of the Revolving Loan website.

1. The prime contractor must pay its subcontractor for work that has been satisfactorily completed no more than 30 days from the prime contractor's receipt of payment from the owner.
2. The prime contractor must notify the owner in writing prior to the termination of any DBE subcontractor for convenience by the prime contractor and employ the Good Faith Efforts if soliciting a replacement contractor.
3. If a DBE contractor fails to complete work under the subcontract for any reason, the prime contractor must employ the Good Faith Efforts if soliciting a replacement contractor.
4. The prime contractor must employ the Good Faith Efforts.

Debarment Certification

The prime contractor must provide a completed **Certification Regarding Debarment, Suspension, and Other Responsibility Matters Form** with its bid or proposal package to the owner (Attachment 2).

Attachment 1

**Disadvantaged Business Enterprise (DBE) Utilization
GOOD FAITH EFFORTS WORKSHEET**

**Michigan Department of Environmental Quality
Office of Drinking Water and Municipal Assistance– Revolving Loan Section
Disadvantaged Business Enterprise (DBE) Utilization
State Revolving Fund/Drinking Water Revolving Fund
GOOD FAITH EFFORTS WORKSHEET**

Bidder: _____

Subcontract Area of Work (one per worksheet): _____

Outreach Goal: Solicit a minimum of three (3) DBEs via email/letter/fax. It is recommended that various sources be used to locate the minimum number of DBEs. The Michigan Department of Transportation (MDOT) website and www.sam.gov registries may be two resources used to find a minimum of three DBEs.

List the DBEs contacted for the above area of work and complete the following information for each DBE.

| Company Name | Type of Contact | Date of Contact | Price Quote Received | Accepted/ Rejected | Please Explain if Rejected |
|--------------|-----------------|-----------------|----------------------|--|----------------------------|
| | | | | <input type="checkbox"/> A <input type="checkbox"/> R | |
| | | | | <input type="checkbox"/> A <input type="checkbox"/> R | |
| | | | | <input type="checkbox"/> A <input type="checkbox"/> R | |
| | | | | <input type="checkbox"/> A <input type="checkbox"/> R | |
| | | | | <input type="checkbox"/> A <input type="checkbox"/> R | |
| | | | | <input type="checkbox"/> A <input type="checkbox"/> R | |

Explanation for Not Achieving a Minimum of Three Contacts; you may include a printout of the MDOT and www.sam.gov search results (attach extra sheets if necessary):

MITA DBE Posting Date (if applicable): _____
(attach a copy of the DBE advertisement)

Other Efforts (attach extra sheets if necessary):

Please include the completed worksheet and supporting documentation with the bid proposal.

Rev.3-2015

Rick Snyder, Governor



Dan Wyant, Director

**Michigan Department of Environmental Quality
Office of Drinking Water and Municipal Assistance– Revolving Loan Section
Disadvantaged Business Enterprise (DBE) Utilization
State Revolving Fund/Drinking Water Revolving Fund
GOOD FAITH EFFORTS WORKSHEET**

Instructions to Bidders for the Completion of the Good Faith Efforts Worksheet

1. Separate worksheets must be provided for each area of work to be subcontracted out. This includes both major and minor subcontracts.
2. A minimum of three (3) DBEs must be contacted by a verifiable means of communication such as e-mail, letter, or fax for each area of work to be subcontracted out. Copies of the solicitation letters/e-mails and fax confirmation sheets must be provided with the worksheet.
3. If less than three (3) DBEs exist statewide for the area of work, then provide documentation that other DBE resources were consulted. This may include the MDOT and www.sam.gov registries and an advertisement in a publication. A printout of the website searched (conducted prior to the end of the bid period) must be submitted.
4. Posting solicitations for quotes/proposals from DBEs on the MITA website (www.mitadbe.com) is highly recommended to facilitate participation in the competitive process whenever possible. The solicitation needs to identify the project and the areas of work to be subcontracted out. A copy of the MITA DBE advertisement must be submitted with the Good Faith Efforts worksheet, if used, or a printout of the resulting quotes posted to the MITA website can be submitted with this form as supporting documentation.
5. If the area of work is so specialized that no DBEs exist, then an explanation is required to support that conclusion, including the documentation required in No. 3 above.
6. The date of the DBE contact must be identified, as it is important to document that the DBE solicitation was made during the bid period and that sufficient time was given for the DBE to return a quote.
7. Each DBE firm's price quote must be identified if one was received or N/A entered on the worksheet if a quote was not received. Copies of all quotes must be submitted with the worksheet.
8. If a quote was received, indicate if it was accepted or rejected. Justification for not accepting a quote and not using the DBE subcontractor must be provided.
9. Under Other Efforts, please indicate additional steps you have taken to obtain DBE contractors and provide the appropriate supporting documentation such as:
 - Follow-up e-mails, faxes, or letters.
 - Copies of announcements/postings in newspapers, trade publications, or minority media that target DBE firms.

Rev. 3-2015

Attachment 2

***Certification Regarding
Debarment, Suspension, and Other Responsibility Matters***

**Certification Regarding
Debarment, Suspension, and Other Responsibility Matters**

The prospective participant certifies, to the best of its knowledge and belief, that it and its principals:

- (1) Are not presently debarred, suspended, proposed for debarment, declared ineligible, or voluntarily excluded from participation in transactions under federal nonprocurement programs by any federal department or agency;
- (2) Have not, within the three year period preceding the proposal, had one or more public transactions (federal, state, or local) terminated for cause or default; and
- (3) Are not presently indicted or otherwise criminally or civilly charged by a government entity (federal, state, or local) and have not, within the three year period preceding the proposal, been convicted of or had a civil judgment rendered against it:
 - (a) For the commission of fraud or a criminal offense in connection with obtaining, attempting to obtain, or performing a public transaction (federal, state, or local) or a procurement contract under such a public transaction;
 - (b) For the violation of federal or state antitrust statutes, including those proscribing price fixing between competitors, the allocation of customers between competitors, or bid rigging; or
 - (c) For the commission of embezzlement, theft, forgery, bribery, falsification or destruction of records, making false statements, or receiving stolen property.

I understand that a false statement on this certification may be grounds for the rejection of this proposal or the termination of the award. In addition, under 18 U.S.C. §1001, a false statement may result in a fine of up to \$10,000 or imprisonment for up to five years, or both.

Name and Title of Authorized Representative

Name of Participant Agency or Firm

Signature of Authorized Representative

Date

I am unable to certify to the above statement. Attached is my explanation.

Attachment 3

***Frequently Asked Questions About
Disadvantaged Business Enterprise (DBE) Solicitation***

Disadvantaged Business Enterprise (DBE) Requirements Frequently Asked Questions Regarding Contractor Compliance

Q: What is the Good Faith Efforts Worksheet form and how is it to be completed?

A: This form captures efforts by the prime contractor to solicit DBEs for each area of work type that will be subcontracted out. A separate Good Faith Efforts Worksheet must be provided by the prime contractor for each area of work type to be subcontracted out. There are specific instructions that accompany this form that prescribe minimum efforts which bidders must make in order to be in compliance with the DBE requirements.

Q: Can non-certified DBEs be used?

A: While non-certified DBEs can be used, only DBEs, MBEs, and WBEs that are certified by EPA, SBA, or MDOT (or by tribal, state and local governments, as long as their standards for certification meet or exceed the standards in EPA policy) can be counted toward the fair share goal. Proof of certification by one of these recognized and approved agencies should be sought from each DBE.

Q: How does a DBE get certified?

A: Applications for certification under MDOT can be found at <http://mdotiboss.state.mi.us/UCP/LearnHowServlet>.

Applications for certification under EPA can be found on EPA's Small Business Programs website at http://www.epa.gov/osbp/dbe_firm.htm under Certification Forms.

Q: If a bidder follows the MDOT DBE requirements, will the bidder be in compliance with the SRF/DWRF DBE requirements?

A: No. Federally funded highway projects utilize DBE goals, which require that a certain percentage of work be performed by DBE subcontractors. For SRF/DWRF projects, there is no financial goal. However, there is a solicitation effort goal. Bidders must use Good Faith Efforts for each and every area of work to be subcontracted out to obtain DBEs. The bidders are not required to use DBEs if the quotes are higher than non-DBE subcontractors. **There is no required DBE participation percentage contract goal for the SRF/DWRF.** However, if the SRF/DWRF project is part of a joint project with MDOT, the project can be excluded from SRF/DWRF DBE requirements (i.e., the Good Faith Efforts Worksheet is not required) as it would be difficult to comply with both programs' requirements.

Q: Must the Good Faith Efforts Worksheet and supporting documentation be turned in with the bid proposals?

A: Yes. This is a requirement to document that the contractor has complied with the DBE requirements and the Good Faith Efforts. These compliance efforts must be done during the bidding phase and not after-the-fact. It is highly recommended that the need for these efforts and the submittal of the forms with the bid proposals be emphasized at the pre-bid meetings. Failure to show that the Good Faith Efforts were complied with during the bidding process can lead to a prime contractor being found non-responsive.

Q: Does EPA form 6100-2 need to be provided at the pre-bid meeting?

A: Yes. The form must be made available at the pre-bid meeting.

- Q:** What kinds of documentation should a contractor provide to document solicitation efforts?
- A:** Documentation can include fax confirmation sheets, copies of solicitation letters/e-mails, printouts of online solicitations, printouts of online search results, affidavits of publication in newspapers, etc.
- Q:** How much time will compliance with the Good Faith Efforts require in terms of structuring an adequate bidding period?
- A:** Due to the extent of the efforts required, a minimum of 30 calendar days is recommended between bid posting and bid opening to ensure adequate time for contractors to locate certified DBEs and solicit quotes.
- Q:** How does a contractor locate certified DBEs?
- A:** The Michigan Department of Transportation has a directory of all Michigan certified entities located at <http://mdotjboss.state.mi.us/UCP/>. Additionally, the federal System for Award Management (SAM) is another place to search and can be found at www.sam.gov. SAM contains information from the former Central Contractor Registration (CCR) database.
- Q:** If the bidder does not intend to subcontract any work, what forms, if any, must be provided with the bid proposal?
- A:** The bidder should complete the Good Faith Efforts Worksheet with a notation that no subcontracting will be done. However, if the bidder is awarded the contract and then decides to subcontract work at any point, then the Good Faith Efforts must be made to solicit DBEs.
- Q:** In the perfect world, the Good Faith Efforts Worksheet is required to be turned in with the proposal. What if no forms are turned in with the bid proposal or forms are blank or incomplete? Should this be cause to determine that the bidder is non-responsive?
- A:** While the Good Faith Efforts Worksheet is important, it is more critical to confirm that the contractor complied with the DBE requirements prior to bid opening. The owner should contact the bidder as soon as deficiencies are noted for a determination/documentation of efforts taken to comply with the DBE requirements. Immediate submittal of the completed forms will be acceptable provided the Good Faith Efforts were made and it is just a matter of transferring information to the forms.
- Q:** If the prime contractor is a DBE, does he have to solicit DBE subcontractors?
- A:** Yes, the DBE requirements still apply if the prime intends to subcontract work out. Good Faith Efforts must be used to solicit DBEs.
- Q:** If the area of work is one where there are less than three DBE contractors, how is the contractor to document this?
- A:** Copies of printouts from MDOT and SAM showing no DBEs and advertisements soliciting quotes for all subcontract areas, including the questionable areas, will be adequate if the dates on the printouts are prior to the bid or proposal closing date.

PROGRESS CLAUSE

1 of 2

City of Owosso/CW/2020 Street Program (Contract 1)

Oct, 2019

The Contractor shall submit at the pre-construction meeting a complete Progress Schedule to the City Engineer. The Progress Schedule shall include, as a minimum, the controlling work items for the completion of the project and the planned dates that these work items will be the controlling operations: all for each of the two project work sites. All Contract dates including open to traffic, project completion, holidays, and other controlling dates of the Contract must be included in the progress schedule. All specific work requirements of the 'Maintaining Traffic' Special Provision that affect the Progress Schedule shall be incorporated within the Progress Schedule.

The Contractor is required to coordinate work with the following criteria for Contract 1:

1. No work shall begin on Summit Street before April 20, 2020.
2. No work shall begin on E North Street before May 18, 2020.
3. The completion date for all work is September 19, 2020.
4. Sewer and road work shall immediately follow completion of water main installation for each work site. Water main installation will be allowed to proceed from work site to work site.
5. All contractor work, except turf restoration and HMA top course must be complete on Summit St before beginning sewer and road work on E North St, unless otherwise directed by the Engineer.
6. Local traffic must be maintained in accordance with the special provision for Maintaining Traffic.

All Contract work must be completed in its entirety, on or before September 19, 2020 with exception for turf establishment as follows: Turf establishment must be placed by September 19, 2020, and the Contractor has until October 17, 2020 to meet specifications associated with the pay item Turf, Establishment. Failure to complete all work within these dates will result in the Contractor being assessed liquidated damages in accordance with subsection 108.10.C.1 of the MDOT 2012 Standard Specifications for Construction.

Unless specific pay items are provided in the Contract, any extra costs incurred by the Contractor due to cold-weather protection, winter grading, sufficient manpower and equipment necessary to maintain the schedule, and/or meet final completion date, and any overtime; will not be paid for separately, but will be included in payment of other contract items.

After award and prior to the start work date, the Contractor must attend a preconstruction meeting with the Engineer. The Engineer will determine the day, time and place for the preconstruction meeting. The Contractor is encouraged to contact any of its sub-contractors to attend the preconstruction meeting. The Contractor and its sub-contractors shall submit a Progress Schedule at the preconstruction meeting and be ready to discuss same at the meeting.

PROGRESS CLAUSE

2 of 2

City of Owosso/CW/2020 Street Program (Contract 1)

Oct, 2019

Failure on the Contractor's part to carry out the provisions of this Project Clause may be considered sufficient cause to prevent Contractor from bidding future projects.

**SPECIAL PROVISION
FOR
TECHNICAL SPECIFICATIONS**

RC/City of Owosso

1 OF 1

Dec, 2018

General Requirement

The MDOT 2012 STANDARD SPECIFICATIONS FOR CONSTRUCTION shall govern all technical specifications for this project. The following parts of the Contract will prevail over all other parts in the following order:

1. Special Provisions.
2. Supplemental Specifications.
3. Project Plans and Drawings.
4. MDOT Standard Plans.
5. 2012 Standard Specifications
6. City of Owosso Standard Specifications.

The Contractor shall not take advantage of any apparent error or omission in the contract documents. If any uncertainty, inconsistency, omission, or conflict is discovered within the contract documents, the Engineer will solely decide as to the true intent of the language.

NOTICE TO BIDDERS

UTILITY COORDINATION

City of Owosso/CW

1 of 2

Oct, 2019

The Contractor shall cooperate and coordinate construction activities with the owners of utilities as stated in Section 104.08 of the Michigan Department of Transportation 2012 Standard Specifications for Construction. In addition, for the protection of underground utilities, the contractor shall follow the requirements in Section 107.12 of the Michigan Department of Transportation 2012 Standard Specifications for Construction. Contractor delay claims, resulting from a utility, will be determined based upon Section 108.09 of the Michigan Department of Transportation 2012 Standard Specifications for Construction.

For protection of underground utilities and in conformance with Public Act 53, the Contractor shall dial 1-800-482-7171 (or 811) a minimum of three full working days, excluding Saturdays, Sundays, and holidays prior to beginning each excavation in areas where public utilities have not been previously located. Members will thus be routinely notified. This does not relieve the Contractor of the responsibility of notifying utility owners who may not be a part of the "Miss Dig" alert system.

The following Public Utilities have facilities located in the road right-of-way or project area:

| <u>NAME AND ADDRESS OF OWNER</u> | <u>KIND OF UTILITY</u> | <u>PHONE NUMBER</u> |
|---|------------------------|--|
| Charter Communication 1480 S. Valley Center Dr Bay City, Michigan 48706 | Cable Television | (989) 233-9404 Mark Kelly mark.kelly@charter.com |
| Frontier 1943 W. M-21 Owosso, Michigan 48867 | Fiber | (989) 723-0373 Mark Stevens mark.stevens@ftr.com |
| Consumers Energy 530 West Willow Street PO Box 30162 Lansing, Michigan 48909 | Gas | (517) 614-8570 Adam Bertram adam.bertram@cmsenergy.com |
| Consumers Energy 530 West Willow Street PO Box 30162 Lansing, Michigan 48906 | Electric | (989) 729-3250 Tracy Mahar tracy.mahar@cmsenergy.com |
| City of Owosso 301 W. Main Street Owosso, Michigan 48867 | Water | (989) 725-0555 Glenn Chinavare glenn.chinavare@ci.owosso.mi.us |

City of Owosso
301 W. Main Street
Owosso, Michigan 48867

Sanitary Sewer

(989) 725-0555
Glenn Chinavare
glenn.chinavare@ci.owosso.mi.us

Daystarr Communications
307 N. Ball Street
Owosso, MI 48867

Fiber

(989) 720-6023
Brent Klein
brent.klein@daystarrfiber.net

Civil Engineer I
301 W. Main Street
Owosso, Michigan 48867

Road and Storm Drainage

(989) 725-0551
Clayton Wehner
clayton.wehner@ci.owosso.mi.us

Soil Erosion and Sedimentation Control
Shiawassee County Health Department
Environmental Health Division
201 N. Shiawassee Street
Corunna, MI 48817

Soil Erosion and
Sedimentation Control

(989) 743-2289
Steve Alworden
salworden@shiwaseechd.net

The owners of existing service facilities that are within grading or structure limits and in conflict will move them to locations designated by the Construction Engineer or will remove them entirely from the highway Right-of-Way. Owners of Public Utilities will not be required by the City of Owosso to move additional poles or structures in order to facilitate the operation of construction equipment unless it is determined by the Construction Engineer that such poles or structures constitute a hazard to the public or are extraordinarily dangerous to the contractor's operations.

The existing utilities shown on the plans represent the best information available as obtained from survey and existing records. This information does not relieve the Contractor of the responsibility of protecting all existing utilities, in case utilities have been constructed or removed since the survey date or if utilities are encountered in different locations or if any utilities are not shown on the plans.

All existing utilities shall be located as to both horizontal and vertical position prior to starting any utility construction or other excavation. Cost shall be included in the new utility or excavation pay item.

The Contractor's attention is directed to the requirements for cooperation with others, as covered in Section 104.08 of the MDOT 2012 Standard Specification for Construction.

UTILITY DAMAGE

The Contractor shall be responsible for the protection of all existing utilities during construction of this project. Any utilities damaged by the Contractor shall be repaired in accordance with the related utilities specifications at the Contractor's expense.

UTILITY REPLACEMENTS

There are no utility replacements for the project.

CITY OF OWOSSO
SPECIAL PROVISION
FOR
MAINTAINING TRAFFIC

City of Owosso/CW

1 of 4

Oct, 2019

a. Description. The project will consist of 0.78 mile of road reconstruction and rehabilitation, including curb and gutter, sidewalk, and storm sewer, on two city streets: E North Street and Summit Street, both in the City of Owosso, Shiawassee County.

b. General. Traffic shall be maintained in accordance with Sections 104.07C, 104.11, 812, and 922 of the Michigan Department of Transportation (MDOT) 2012 Standard Specifications for Construction, including any typicals or supplemental specifications and as specified herein.

The Contractor shall coordinate their operations with other Contractors, City of Owosso forces, private utilities, and Owosso Public Schools who are within the CIA to eliminate conflicts in traffic control. No additional payment will be made to the Contractor for the joint use of traffic control items.

The Contractor shall notify the Engineer, City of Owosso (989-725-0550), Shiawassee County Central Dispatch (989-743-9111), Local Fire Department(s) (989-725-0580), Owosso High School (989-723-8231), and School Operations Director (989-413-5246) that service the area a minimum of three full working days prior to the implementation of any detours or road closures.

c. Construction Influence Area (CIA). The Construction Influence Area (CIA) shall include both right-of-ways of E North Street and Summit Street and extend a distance of 0.5 miles beyond the endpoints and include the right-of-way of all intersecting streets within the project limits for a distance of 300 feet laterally from the construction centerlines of both E North Street and Summit Street.

The CIA shall also include the rights-of-way of any designated detour routes within the limits of the construction and detour signing.

d. Traffic Restrictions. E North Street and Summit Street shall be closed to through traffic. A detour route shall be in place for E North Street using N Hickory St and E King St. Residents shall be allowed to access their homes on both E North and Summit Streets at all times.

Contractor shall use the City of Owosso Truck Route System. Contractor will be allowed to use North Street from M-52 to the work site and Gould Street from M-21 to the work site. Loaded trucks are prohibited on surrounding streets, especially Abbott St, Brandon St, Rubelman Dr, Krust Dr, and Whitehaven Ct.

The intersection at E North and N Gould Streets may be intermittently closed during the day, but shall be open at night. Traffic Regulators shall be used to allow traffic to operate through the intersection and around the construction area.

Reasonable access to intersecting roads/streets and residential/commercial drives shall be maintained at all times, including access to Owosso High School. The Contractor may temporarily close alternate drives if a business or residence has multiple drives on the same roadway, except for drives that operate directionally (i.e., one-way drives). The Owosso High School driveway just west of N Gould Street shall remain open and accessible. While work is conducted in that area, the Owosso High School driveway just east of Rubelman Drive shall be open and accessible for school traffic. The Contractor shall give 24 hour notice of any change in access. The Contractor shall allow access for intermittent deliveries to Owosso High School. Owosso High School shall give the Contractor 24 hour notice of said deliveries.

The Contractor shall allow access for intermittent deliveries to Owosso High School. Owosso High School is expected to give the Contractor 24 hour notice of said deliveries.

The Contractor shall notify the Engineer a minimum of one week prior to changing patterns on E North Street and Summit Street.

All traffic regulators assigned to traffic control must receive all necessary instruction and training prior to starting operations.

The Contractor shall work between the hours of 7:00 a.m. and 7:00 p.m., Monday through Saturday. No work is allowed outside these time periods. From September 8, 2020 to September 19, 2020, the Contractor shall limit work to areas that do not disrupt access to the Owosso High School from 7:00 a.m. to 8:00 a.m. for morning drop off and from 3:00 p.m. to 4:00 p.m. for afternoon pick-up. The Contractor must provide a 72-hour notice for Saturday work. The Contractor shall coordinate work so that any necessary preliminary or closing operations are also done within these time periods.

The Contractor shall be advised that Owosso High School's tentative dismissal date is June 5, 2020. The school is tentatively expected to resume again on approximately September 8, 2020.

Public utility service to Owosso High School shall not be disrupted while school is in session.

No work shall be allowed during the Memorial Day or Labor Day weekends or the Fourth of July holiday period. The Memorial Day weekend shall begin on Friday, May 22, 2020 at 3:00 p.m. and continue until Tuesday, May 26, 2020 at the normal starting time. The Fourth of July holiday period shall begin on Thursday, July 2, 2020 at 3:00 p.m. and continue until Monday, July 6, 2020 at the normal starting time. The Labor Day weekend shall begin on Friday, September 4, 2020 at 3:00p.m. and continue until Tuesday, September 9, 2020 at the normal starting time.

The Contractor shall place maintenance gravel the same workday that the pavement is removed in all locations of the project to maintain access to adjacent properties. Any damage occurring to the subgrade from exposure to the elements will be undercut and replaced in accordance with Subgrade Undercutting, Type II, at the Contractor's expense.

The Contractor shall place aggregate base the same workday that earth is excavated in all locations of the project. Any damage occurring to the subgrade from exposure to the elements will be undercut and replaced in accordance with Subgrade Undercutting, Type II, at the Contractor's expense.

Rubbish collection is done by private contractors between the hours of 7:00 a.m. and 7:00 p.m. according to the following schedule: All residential customers north of Main Street are serviced on Thursdays. All residential customers south of Main Street are serviced on Tuesdays. Rubbish collected at commercial properties is collected any time/date. The Contractor shall schedule work to allow and provide for rubbish collectors to provide their service to the residential and commercial properties. If the rubbish collectors are unable to collect materials due to construction operations, then the Contractor shall coordinate with the rubbish collectors the moving of containers to the collection site and returning same containers to the property owner.

Current mail delivery is both via mailbox and doorstep. Mail delivery person will park vehicle on side-street and walk to residence to make doorstep delivery. Contractor shall conduct work so that the mail person may drive and walk unimpeded around construction work to make mail delivery.

e. Traffic Control Devices. All signs, barricades, warning lights, and other traffic control devices shall be in accordance with the 2011 Edition of the Michigan Manual of Uniform Traffic Control Devices (MMUTCD) and conform to MDOT Special Detail WZD-125-E.

All diamond shaped warning signs shall be 48" x 48." All temporary signs shall be mounted at a minimum seven-foot bottom height. All temporary signs used for detour, except those at Type III Barricades, shall be installed on driven posts.

Temporary signs which are to remain in place for fourteen (14) days or more shall be installed on driven posts as directed by the Engineer. All other temporary signs (excluding detour signs) may be installed on portable supports.

Ground driven sign supports for temporary signs shall be installed in accordance with MDOT Special Detail WZD-100-A.

Advance work zone signing is revised to include R5-18c (Work Zone Begins) signs. Install signs at locations shown in the plans or as directed by the engineer.

For construction signing, layout as shown on MDOT typicals minimum Merging Taper Lengths "L," distances between Traffic Control Devices "D," and length of Longitudinal Buffer Length "B" shall be in accordance with Typical Sign Sequence M0020a.

If required, for a single lane daytime closure on E North or Summit, local traffic shall be maintained utilizing traffic regulators, signing, and traffic control devices shall be placed in accordance with the Typical Sign Sequence M0140a, or as directed by the Engineer.

When traffic regulators (flaggers) are utilized, intermediate traffic regulators (flaggers) shall be established at intersecting roads, streets, and at other traffic generators as directed by the Engineer.

W20-1 "Road Work Ahead" signs shall be placed on all intersecting roads at a minimum distance shown on the plans, or as directed by the Engineer.

Signs placed at Type III barricades shall be placed above and behind the barricade on their own supports.

The speed limit through the construction zone shall be set at 25 mph.

Type C Lighted Arrow Panels (4' x 8') shall be used where lighted arrow panels are called for and located at the beginning of the taper, or as shown on the Typical Sign Sequence layouts unless physical limitations restrict its placement. The Lighted Arrow Panel shall then be located as near as possible to the beginning of the taper.

A quantity of plastic drums with high intensity sheeting has been established for lane closures and to be used adjacent to work areas.

f. Temporary Pavement Markings. Temporary pavement markings shall consist of:

Pavt Mrkg, Type NR, Tape, 4 inch, Yellow, Temp
Pavt Mrkg, Wet Reflective, Type R, Tape, 4 inch, Yellow, Temp

Temporary Pavement Markings, Type NR, Tape, 4 inch, Yellow, Temp are to be used as temporary lane line markings on the leveling courses throughout the project length. Quantities are based on single 4' long x 4" wide marking at 50' intervals.

Temporary Pavement Markings, Wet Reflective, Type R, Tape, 4 inch, Yellow, Temp are to be used as temporary lane line marking (including tapers) on the final surface course.

Quantities are based on 4' long x 4" wide marking at 50' intervals for lane line markings.

Temporary pavement markings on the final surface course shall be Wet Reflective Type R and placed as shown in the Permanent Pavement Marking and Signing Plans.

g. Permanent Pavement Markings. Permanent pavement markings shall consist of:

Pavt Mrkg, Ovly Cold Plastic, 6 inch, Crosswalk
Pavt Mrkg, Ovly Cold Plastic, 24 inch, Stop Bar
Pavt Mrkg, Ovly Cold Plastic, Rt Turn Arrow Sym
Pavt Mrkg, Ovly Cold Plastic, Thru and Lt Turn Arrow Sym
Pavt Mrkg, Waterborne, 4 inch, White for edge line markings
Pavt Mrkg, Waterborne, 4 inch, Yellow for centerline markings

Final pavement markings shall be installed within 3 days of placement of the top course (weather permitting).

The contractor shall place permanent pavement markings in accordance with Section 811 of the MDOT 2012 Standard Specifications for Construction, the Pavement Marking Plans, and the most current version of the MDOT Pavement Marking Typical Plans PAVE-900-Series.

h. Measurement and Payment. The Maintaining Traffic Pay Items will be paid for at the Contract Unit Price in accordance with the MDOT 2012 Standard Specifications for Construction, with exception by other Special Provisions, which shall be payment in full for all labor, material, and equipment needed to accomplish this work.

Payment for temporary signs will be made based on the maximum square feet of dissimilar sign legends in use at any one time during the project.

Payment for barricades, lighted arrows, and plastic drums will be made based on the maximum number in use at any one time during the project.

CITY OF
OWOSSO
SHIawassee COUNTY
T. 7 N.-R. 2 & 3 E.
POP. 17,179 - 1970 CENSUS

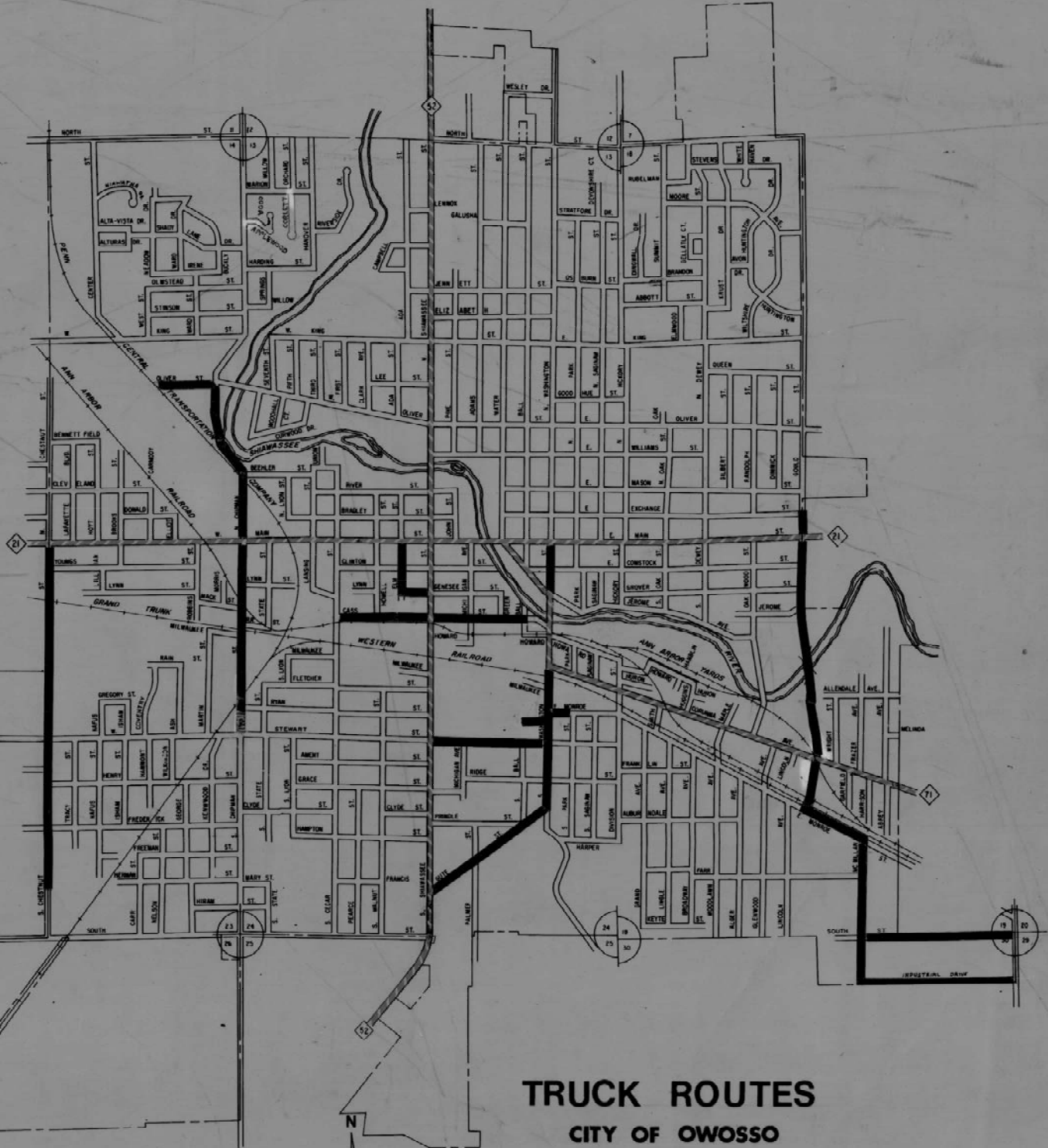

TRUCK ROUTES
CITY OF OWOSSO

TRAFFIC CONTROL ORDER
EFFECTIVE DATE 6-15-81

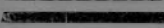
STATE HIGHWAY 
DESIGNATED TRUCK ROUTES 

SCALE

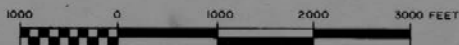

SIGN MATERIAL SELECTION TABLE

| SIGN SIZE | SIGN MATERIAL TYPE | | |
|--------------------------|--------------------|---------|----------|
| | TYPE I | TYPE II | TYPE III |
| ≤ 36" X 36" | | X | X |
| >36" X 36" < 96" TO WIDE | | X | |
| > 96" WIDE TO 144" WIDE | X | X | |
| > 144" WIDE | X | | |

TYPE I ALUMINUM EXTRUSION
 TYPE II PLYWOOD
 TYPE III ALUMINUM SHEET

ROUNDING OF CORNERS IS NOT REQUIRED FOR TYPE I OR II SIGNS.
 VERTICAL JOINTS ARE NOT PERMITTED.
 HORIZONTAL JOINTS THROUGH SIGN LEGEND OR SYMBOLS ARE NOT PERMITTED.

POST SIZE REQUIREMENTS TABLE

| SIGN AREA (ft ²) | POST TYPE | | |
|---------------------------------|-----------------|----------------------|--------------|
| | U-CHANNEL STEEL | SQUARE TUBULAR STEEL | WOOD |
| ≤9 | 1 - 3 lb/ft* | 1 - 2" 12 or 14 GA* | N/A |
| 9 ≤ 20 | 2 - 3 lb/ft | 2 - 2" 12 or 14 GA | 1 - 4" X 6"* |
| > 20 ≤ 30 | N/A | N/A | 2 - 4" X 6" |
| > 30 ≤ 60 | N/A | N/A | 2 - 6" X 8" |
| > 60 ≤ 84 | N/A | N/A | 3 - 6" X 8" |

*SIGNS 4 FEET AND GREATER IN WIDTH REQUIRE 2 POSTS.
 SIGNS GREATER THAN 8 FEET IN WIDTH REQUIRE 2 OR 3 WOOD
 POSTS DEPENDING ON AREA OF SIGN.
 A MAXIMUM OF 2 POSTS WITHIN A 7' PATH IS PERMITTED.

| | | | | |
|---|--|--|----------------------------|-------------------------------|
|  PREPARED BY OPERATIONS FIELD SERVICES | DEPARTMENT DIRECTOR Kirk T. Steudle APPROVED BY: _____ DIRECTOR, BUREAU OF FIELD SERVICES | MICHIGAN DEPARTMENT OF TRANSPORTATION BUREAU OF FIELD SERVICES SPECIAL DETAIL FOR GROUND DRIVEN SIGN SUPPORTS FOR TEMP SIGNS | | |
| | DRAWN BY: <u>CON/ECH</u> CHECKED BY: <u>AUG</u> | APPROVED BY: _____ DIRECTOR, BUREAU OF HIGHWAY DEVELOPMENT | _____ F.H.W.A. APPROVAL | <u>7/20/2016</u> PLAN DATE |

2 POST SIGN SUPPORT SPACING

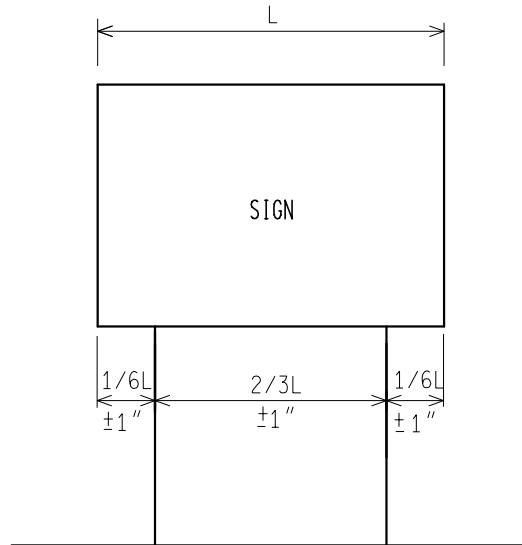

3 POST SIGN SUPPORT SPACING

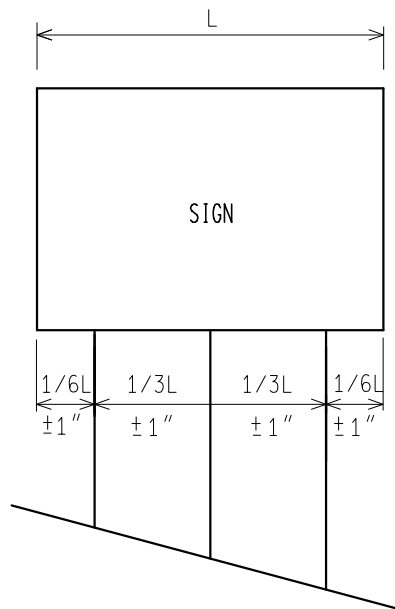

* FOR ALL 11' AND 12' LONG SIGNS ON 3 WOOD SUPPORTS, SPREAD POSTS SO AS TO HAVE A 8' MIN. TO 9' MAX. DISTANCE BETWEEN OUTSIDE POSTS.

NOT TO SCALE

MICHIGAN DEPARTMENT OF TRANSPORTATION
BUREAU OF FIELD SERVICES SPECIAL DETAIL

F.H.W.A. APPROVAL

7/20/2016
PLAN DATE

WZD-100-A

SHEET
2 OF 11

NOTE: THE ORIGINAL SIGNED COPY IS KEPT ON FILE AT THE MICHIGAN DEPARTMENT OF TRANSPORTATION.

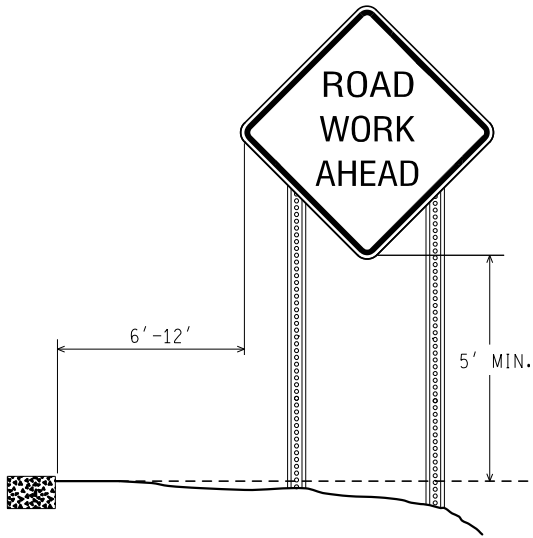

RURAL

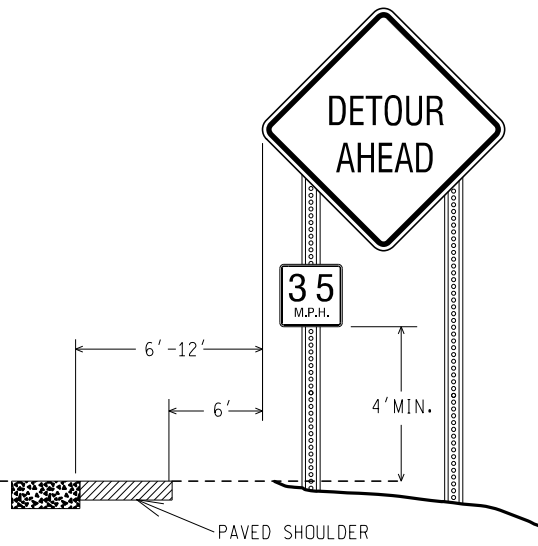

RURAL WITH ADVISORY SPEED PLATE

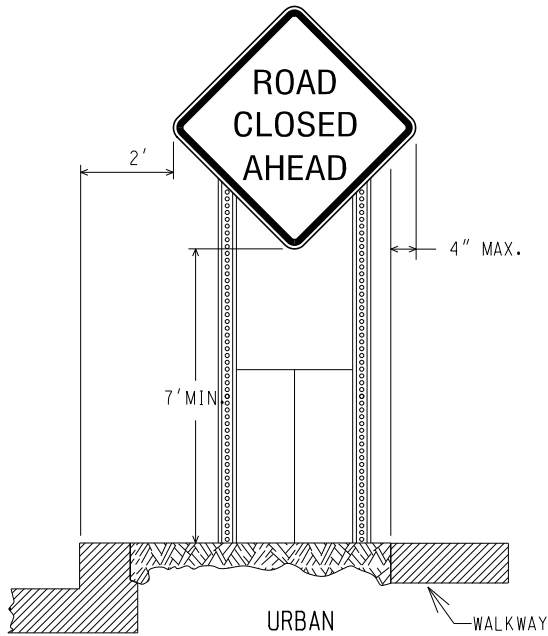

URBAN

(CURBED AREAS OR WHERE WALKWAYS ARE PRESENT)

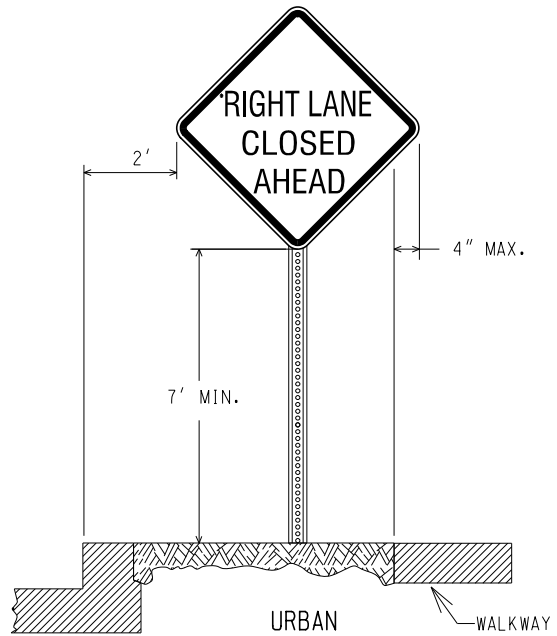

URBAN

(CURBED AREAS OR WHERE WALKWAYS ARE PRESENT)

BOTTOM HEIGHT AND OFFSET

NOT TO SCALE

MICHIGAN DEPARTMENT OF TRANSPORTATION
BUREAU OF FIELD SERVICES SPECIAL DETAIL

F.H.W.A. APPROVAL

7/20/2016
PLAN DATE

WZD-100-A

SHEET
3 OF 11

NOTE: THE ORIGINAL SIGNED COPY IS KEPT ON FILE AT THE MICHIGAN DEPARTMENT OF TRANSPORTATION.

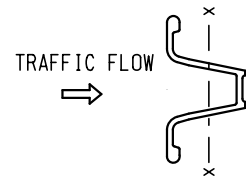
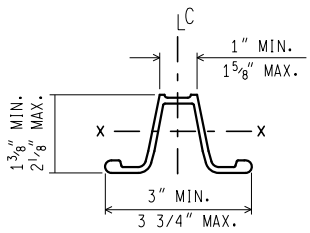
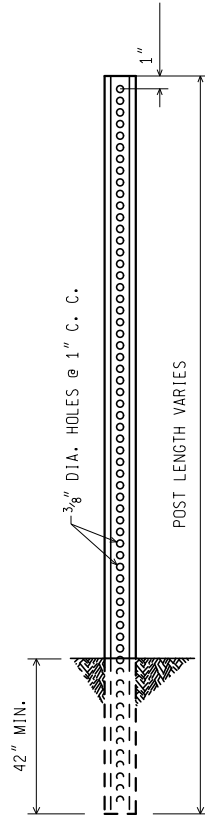

WEIGHT = 3 lbs/ft
 SECT. MOD. X.-X. = 0.31 CUBIC INCHES MIN.

3 lb. U - CHANNEL STEEL POST
 (NO SPLICE)

MOUNT SIGN ON OPEN FACE OF
 U - CHANNEL STEEL POST

NOT TO SCALE

| | | | | |
|--|-------------------|------------------------|-----------|------------------|
| MICHIGAN DEPARTMENT OF TRANSPORTATION BUREAU OF FIELD SERVICES SPECIAL DETAIL | F.H.W.A. APPROVAL | 7/20/2016 PLAN DATE | WZD-100-A | SHEET 4 OF 11 |
|--|-------------------|------------------------|-----------|------------------|

NOTE: THE ORIGINAL SIGNED COPY IS KEPT ON FILE AT THE MICHIGAN DEPARTMENT OF TRANSPORTATION.

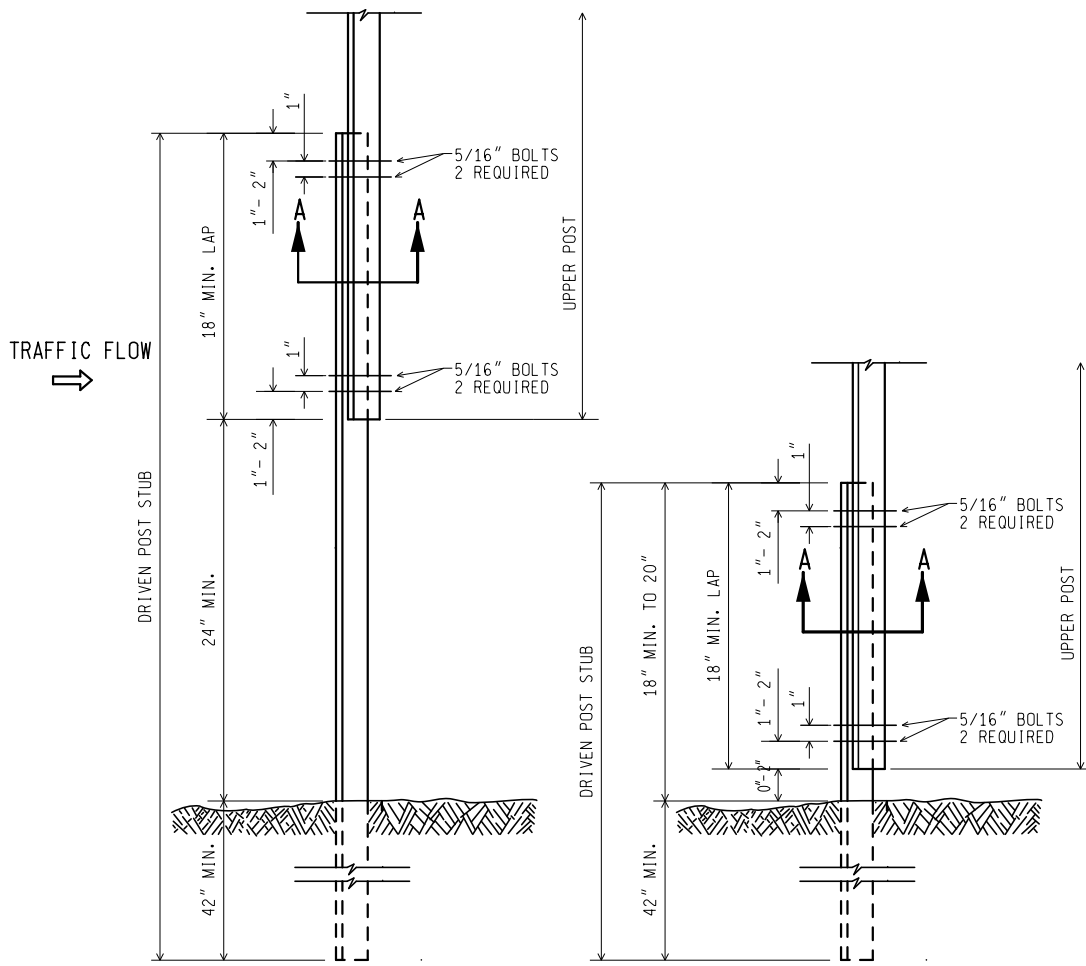

UPPER SPLICE

LOWER SPLICE

3 lb. U - CHANNEL STEEL POST
(WITH SPLICE)

MOUNT SIGN ON OPEN FACE OF
UPPER U - CHANNEL STEEL POST

NOT TO SCALE

| | | | | |
|--|-------------------|------------------------|-----------|------------------|
| MICHIGAN DEPARTMENT OF TRANSPORTATION BUREAU OF FIELD SERVICES SPECIAL DETAIL | F.H.W.A. APPROVAL | 7/20/2016 PLAN DATE | WZD-100-A | SHEET 5 OF 11 |
|--|-------------------|------------------------|-----------|------------------|

NOTE: THE ORIGINAL SIGNED COPY IS KEPT ON FILE AT THE MICHIGAN DEPARTMENT OF TRANSPORTATION.

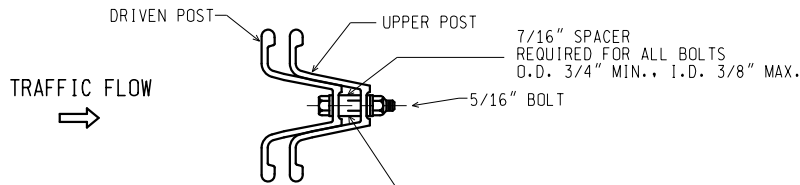

SECTION A-A

7/16" SPACER
 REQUIRED FOR ALL BOLTS
 O.D. 3/4" MIN., I.D. 3/8" MAX.

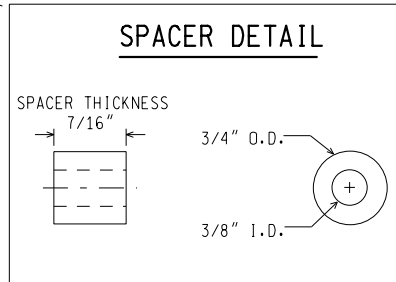

NOTES:

1. THE SPACER THICKNESS SHALL BE 1/16" LESS THAN THE GAP BETWEEN THE POST WHEN POSITIONED IN THE UNBOLTED CONFIGURATION.
2. THE EXTERIOR BOLT (CLOSEST TO LAP), SPACER, WASHER, AND NUT SHALL BE INSTALLED IN A PREPUNCHED HOLE 1" TO 2" FROM THE END OF THE LAP.
3. THE INTERIOR BOLT (FARTHEST FROM LAP), SPACER, WASHER, AND NUT SHALL BE INSTALLED IN THE NEXT PREPUNCHED HOLE.
4. THE DRIVEN POST SHALL ALWAYS BE MOUNTED IN FRONT OF THE UPPER POST WITH RESPECT TO THE ADJACENT ONCOMING TRAFFIC, REGARDLESS OF THE DIRECTION THE SIGN IS FACING.
5. THE SPLICE LAP SHALL BE FASTENED BY FOUR-5/16" DIA. GALVANIZED A449 BOLTS (SAE J429 GRADE 5) OR GALVANIZED A325 BOLTS.

3 lb. U - CHANNEL STEEL POST
 (WITH SPLICE)

NOT TO SCALE

| | | | | |
|--|-------------------|------------------------|-----------|------------------|
| MICHIGAN DEPARTMENT OF TRANSPORTATION BUREAU OF FIELD SERVICES SPECIAL DETAIL | F.H.W.A. APPROVAL | 7/20/2016 PLAN DATE | WZD-100-A | SHEET 6 OF 11 |
|--|-------------------|------------------------|-----------|------------------|

NOTE: THE ORIGINAL SIGNED COPY IS KEPT ON FILE AT THE MICHIGAN DEPARTMENT OF TRANSPORTATION.

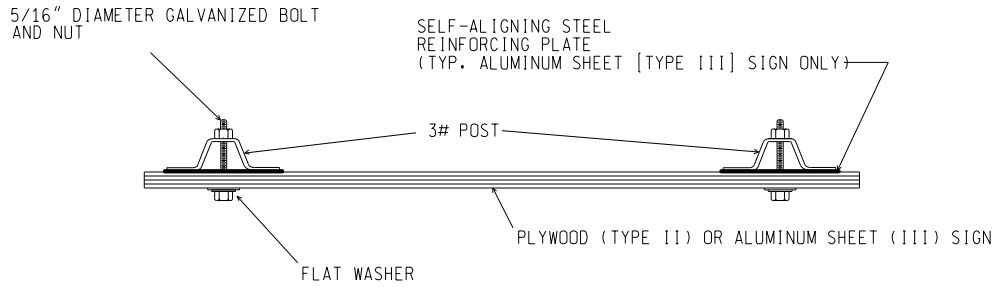

SIGN TO 3 lb. POST CONNECTION

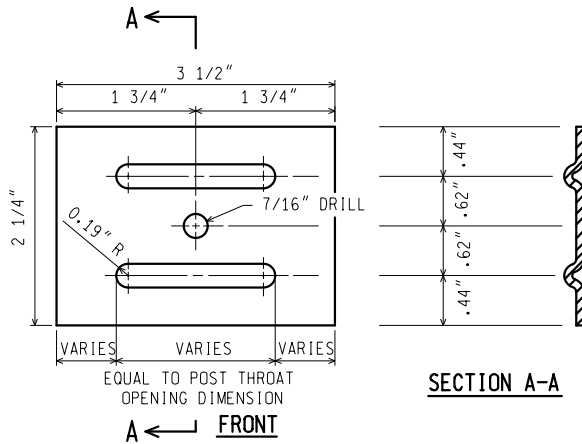

NOTES: (FOR STEEL SIGN REINF' PLATE)

1. MATERIAL: 12 GAUGE CARBON STEEL.
2. TOLERANCE ON ALL DIMENSIONS $\pm 0.0625"$
3. FINISH-AFTER STAMPING AND PUNCHING, GALVANIZE ACCORDING TO CURRENT SPECIFICATIONS FOR ZINC (HOT GALVANIZE) COATINGS ON PRODUCTS FABRICATED FROM PLATES OR STRIPS

STEEL SIGN REINFORCING PLATE
REQUIRED FOR TYPE III SIGNS ONLY

3 lb. U - CHANNEL STEEL POST SIGN CONNECTION

NOT TO SCALE

MICHIGAN DEPARTMENT OF TRANSPORTATION
BUREAU OF FIELD SERVICES SPECIAL DETAIL

F.H.W.A. APPROVAL

7/20/2016
PLAN DATE

WZD-100-A

SHEET
7 OF 11

NOTE: THE ORIGINAL SIGNED COPY IS KEPT ON FILE AT THE MICHIGAN DEPARTMENT OF TRANSPORTATION.

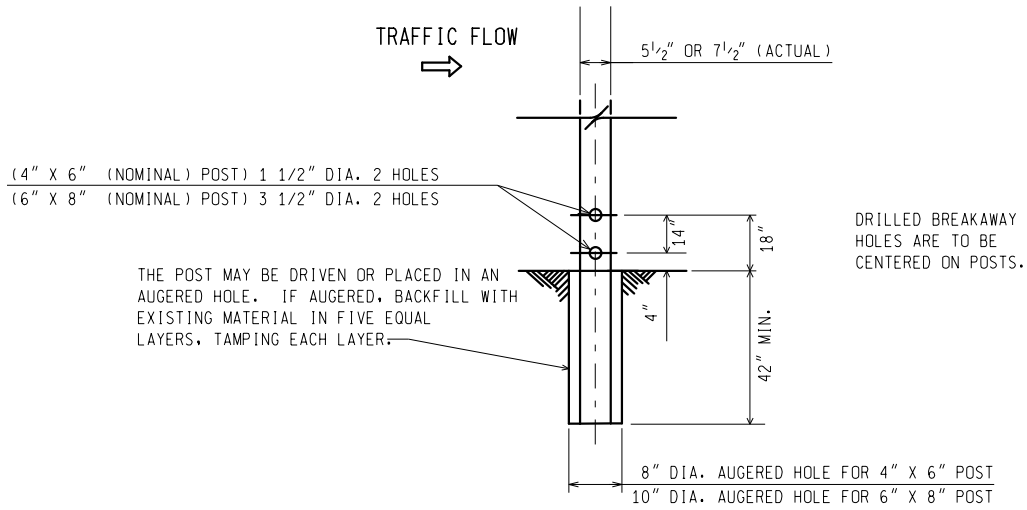

WOOD POST BREAKAWAY HOLES/
 DIRECT EMBEDMENT DETAILS

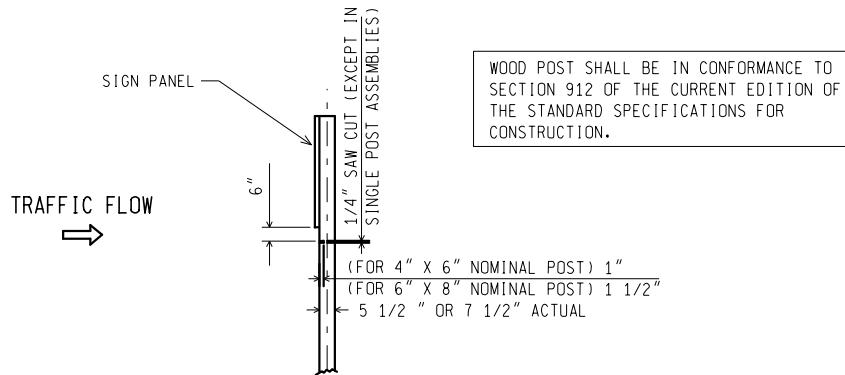

SAW CUT DETAIL
 (MULTIPLE POST INSTALLATIONS)

WOOD POST DETAILS

NOT TO SCALE

| | | | | |
|--|-------------------|------------------------|-----------|------------------|
| MICHIGAN DEPARTMENT OF TRANSPORTATION BUREAU OF FIELD SERVICES SPECIAL DETAIL | F.H.W.A. APPROVAL | 7/20/2016 PLAN DATE | WZD-100-A | SHEET 8 OF 11 |
|--|-------------------|------------------------|-----------|------------------|

NOTE: THE ORIGINAL SIGNED COPY IS KEPT ON FILE AT THE MICHIGAN DEPARTMENT OF TRANSPORTATION.

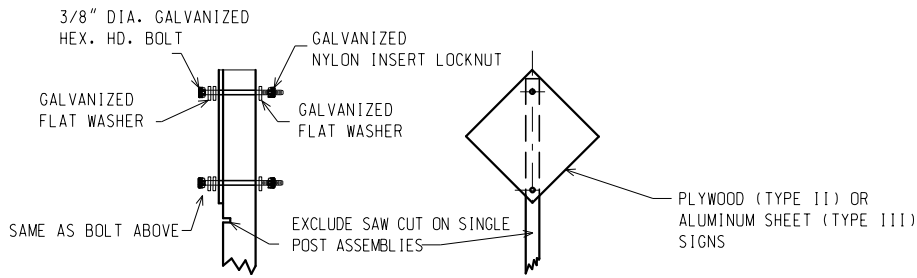

TYPE II AND TYPE III SIGNS

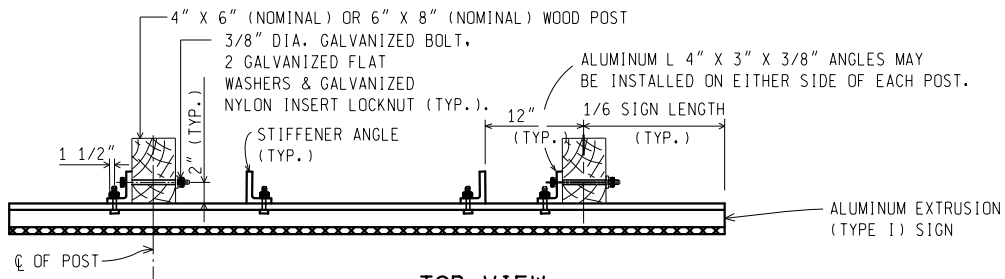

**TOP VIEW
 TYPE I SIGN**

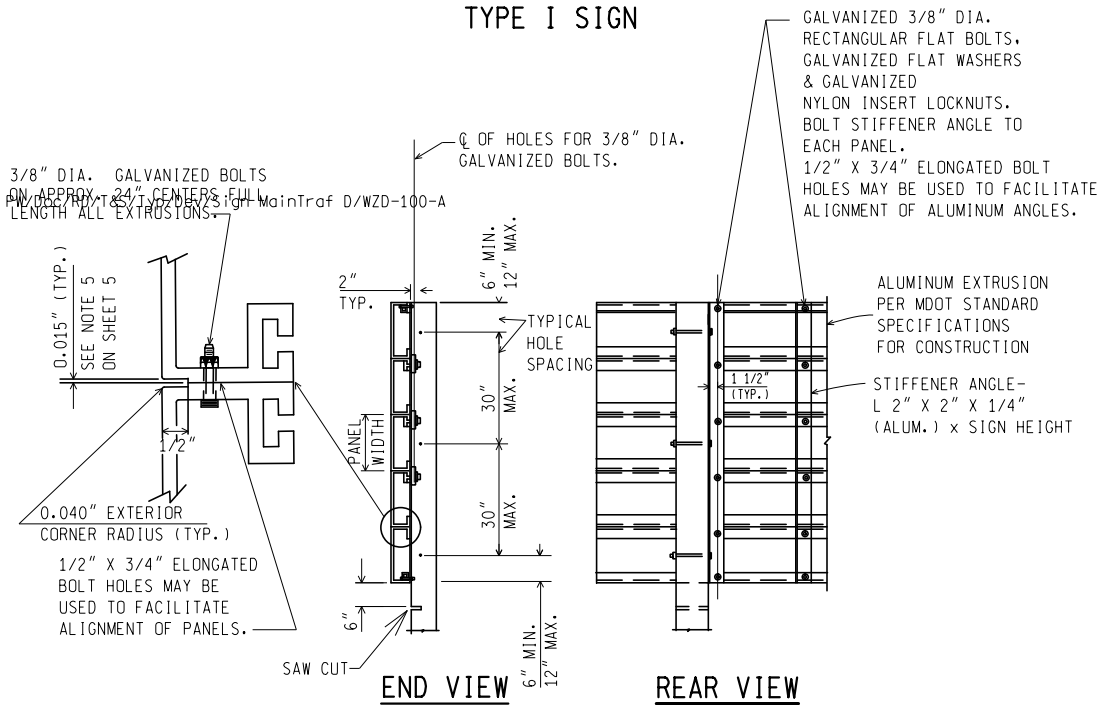

TYPE I SIGN - ERECTION DETAILS

WOOD POST CONNECTIONS

NOT TO SCALE

MICHIGAN DEPARTMENT OF TRANSPORTATION
 BUREAU OF FIELD SERVICES SPECIAL DETAIL

F.H.W.A. APPROVAL

7/20/2016
 PLAN DATE

WZD-100-A

SHEET
 9 OF 11

NOTE: THE ORIGINAL SIGNED COPY IS KEPT ON FILE AT THE MICHIGAN DEPARTMENT OF TRANSPORTATION.

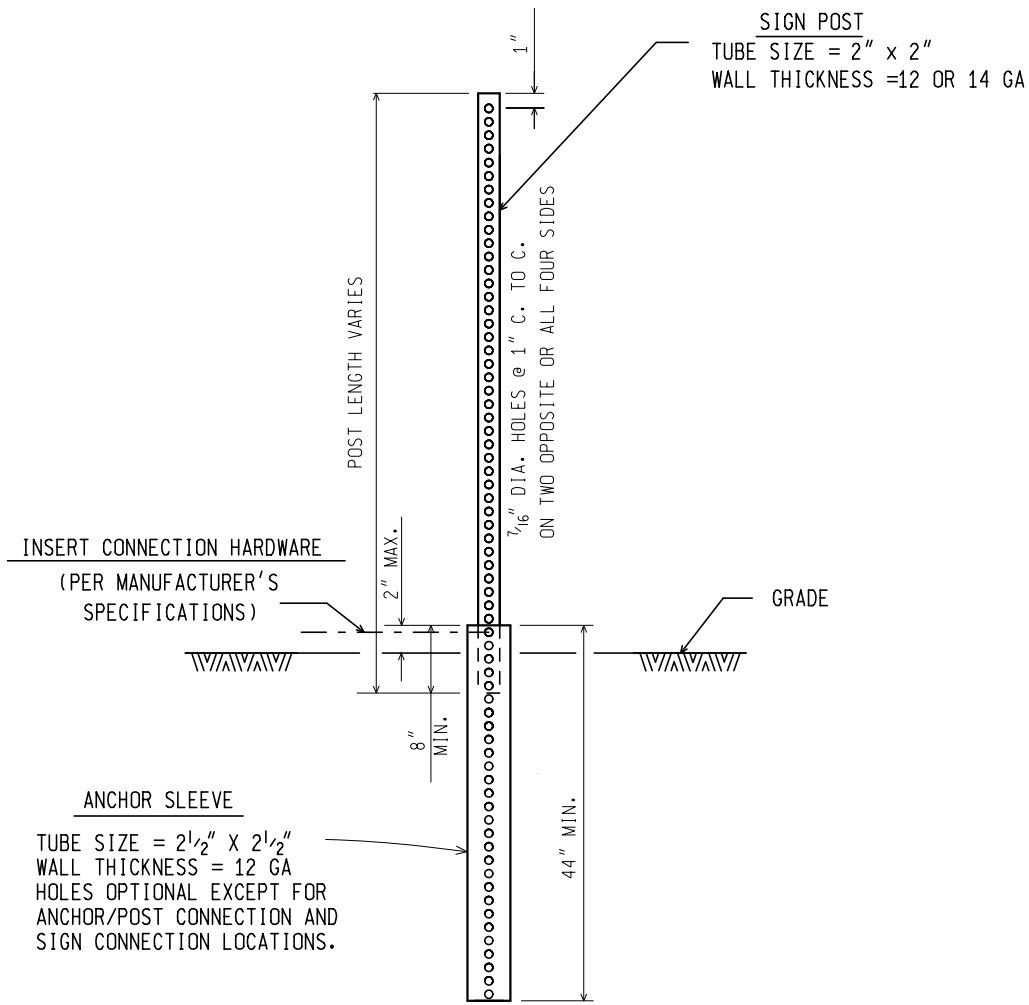

SQUARE TUBULAR STEEL POST

NOT TO SCALE

| | | | | |
|--|-------------------|------------------------|-----------|-------------------|
| MICHIGAN DEPARTMENT OF TRANSPORTATION BUREAU OF FIELD SERVICES SPECIAL DETAIL | F.H.W.A. APPROVAL | 7/20/2016 PLAN DATE | WZD-100-A | SHEET 10 OF 11 |
|--|-------------------|------------------------|-----------|-------------------|

NOTE: THE ORIGINAL SIGNED COPY IS KEPT ON FILE AT THE MICHIGAN DEPARTMENT OF TRANSPORTATION.

GENERAL NOTES:

1. A MAXIMUM OF TWO POSTS WITHIN A 7 FOOT PATH IS PERMITTED.
2. ALL SIGN POSTS SHALL COMPLY WITH NCHRP 350.
3. ALL POSTS SHALL BE EMBEDDED A MINIMUM OF 42".
4. BRACING OF POST IS NOT PERMITTED.
5. SIGN SHALL BE LEVEL, AND UPRIGHT FOR THE DURATION OF INSTALLATION.
6. ERECT POSTS SO THE SIGN FACE AND SUPPORTS DO NOT VARY FROM PLUMB BY MORE THAN 3/16" IN 3'. PROVIDE A CENTER-TO-CENTER DISTANCE BETWEEN POSTS WITHIN 2 PERCENT OF PLAN DISTANCE.
7. NO MORE THAN ONE SPLICE PER POST, AS SHOWN, WILL BE PERMITTED.
8. POST TYPES SHALL NOT BE MIXED WITHIN A SIGN SUPPORT INSTALLATION.
9. NO VERTICAL JOINTS ARE PERMITTED IN SIGN. NO HORIZONTAL JOINTS THROUGH SIGN LEGEND OR SYMBOLS ARE PERMITTED IN SIGN
10. REMOVE SIGN POSTS AND/OR POST STUBS IN THEIR ENTIRETY WHEN NO LONGER REQUIRED.
11. ALL LABOR, MATERIALS, AND EQUIPMENT, INCLUDING TEMPORARY SUPPORTS REQUIRED TO INSTALL, MAINTAIN, RELOCATE, AND/OR REMOVE THE TEMPORARY SIGN, INCLUDING SUPPORTS, ARE CONSIDERED TO BE INCLUDED IN THE COST OF THE TEMPORARY SIGN.
12. SAW CUTS IN WOOD POSTS ARE TO BE PARALLEL TO THE BOTTOM OF THE SIGN.
13. POSTS SHALL NOT EXTEND MORE THAN 4" ABOVE TOP OF SIGN.
14. TEMPORARY WOOD SUPPORTS DO NOT REQUIRE PRESERVATIVE TREATMENT.

NOT TO SCALE

| | | | | |
|--|-------------------|------------------------|-----------|-------------------|
| MICHIGAN DEPARTMENT OF TRANSPORTATION BUREAU OF FIELD SERVICES SPECIAL DETAIL | F.H.W.A. APPROVAL | 7/20/2016 PLAN DATE | WZD-100-A | SHEET 11 OF 11 |
|--|-------------------|------------------------|-----------|-------------------|

NOTE: THE ORIGINAL SIGNED COPY IS KEPT ON FILE AT THE MICHIGAN DEPARTMENT OF TRANSPORTATION.

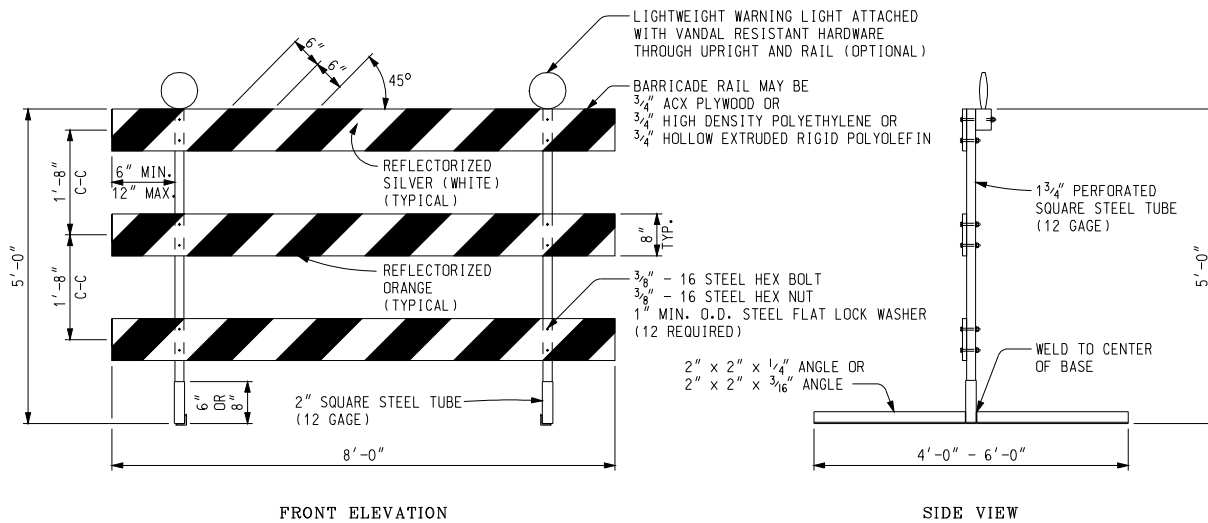

FRONT ELEVATION

SIDE VIEW

PERFORATED SQUARE STEEL TUBE OPTION

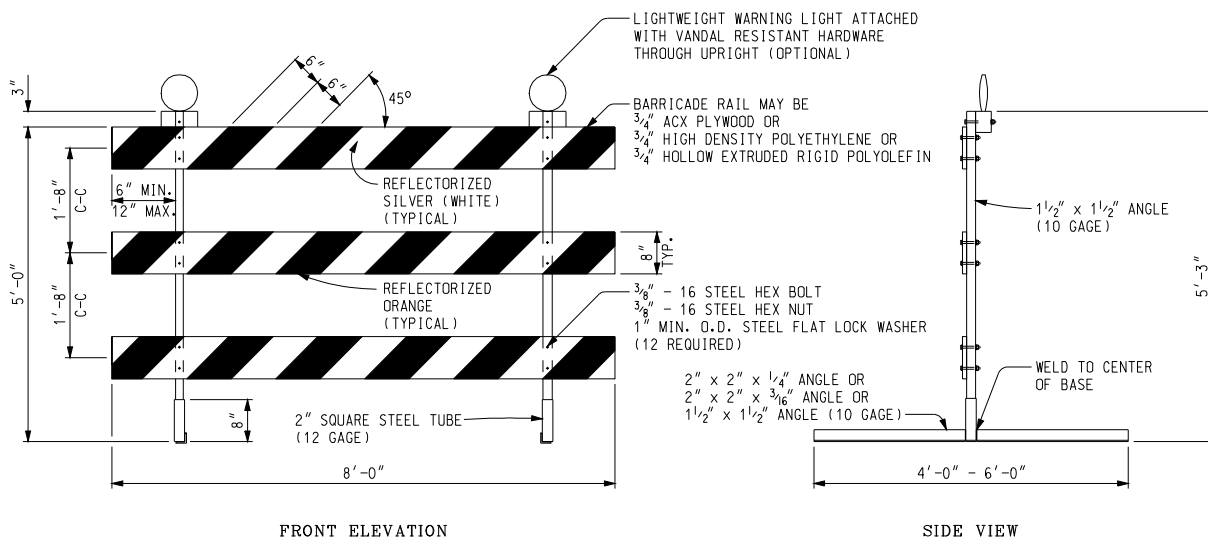

FRONT ELEVATION

SIDE VIEW

ANGLE IRON OPTION

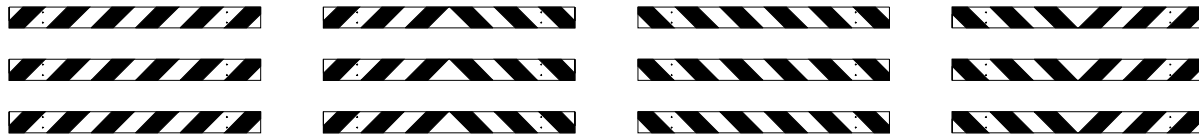

LEFT DIRECTIONAL

BI-DIRECTIONAL

RIGHT DIRECTIONAL

CLOSURES

BARRICADE RAIL SHEETING OPTIONS
TYPE III BARRICADES

Other Type III Barricades meeting current NCHRP crash worthy criteria can be found on the FHWA Safety website at http://safety.fhwa.dot.gov/roadway_dept/road_hardware/wzd.htm

NOT TO SCALE

File: T&S/Typ/Signs/WorkZones/wzd 125 d

Rev. 09/22/09 PJ



PREPARED BY
TRAFFIC AND SAFETY

ENGINEER OF DELIVERY

ENGINEER OF DEVELOPMENT

(SPECIAL DETAIL)

FHWA APPROVAL DATE

MICHIGAN DEPARTMENT OF TRANSPORTATION
BUREAU OF HIGHWAYS DELIVERY STANDARD PLAN FOR

Temporary
Traffic Control Devices

9/22/09
PLAN DATE

WZD-125-E

SHEET
1 of 3

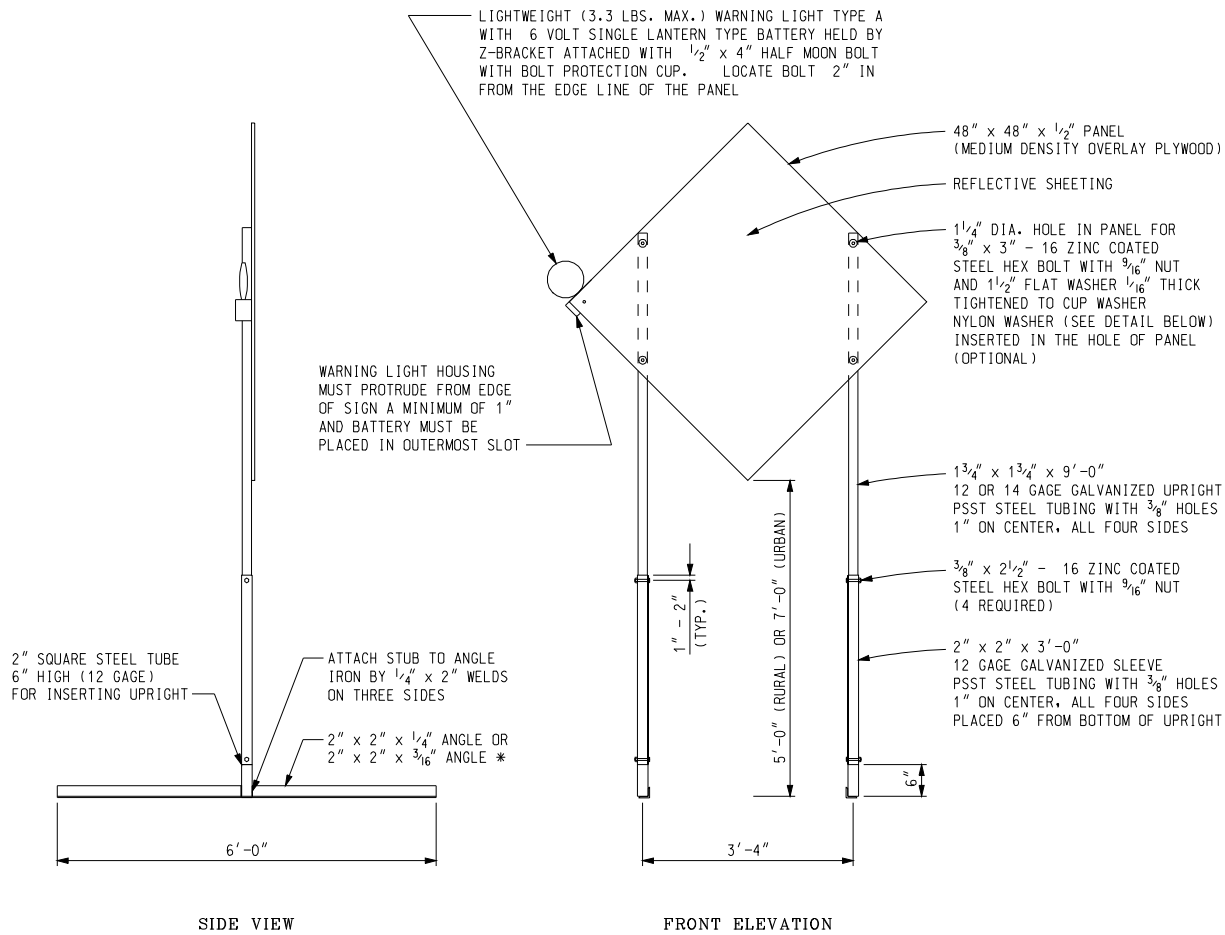

TEMPORARY SIGN SUPPORT

(WARNING LIGHT PLACED ON SIDE CLOSEST TO TRAFFIC)

* SIGN STAND IS BALLASTED WITH FOUR OR MORE 35 LB SANDBAGS. A MINIMUM OF ONE ON EACH END.
 UPRIGHTS SHALL NOT EXTEND ABOVE THE SIGN PANEL.

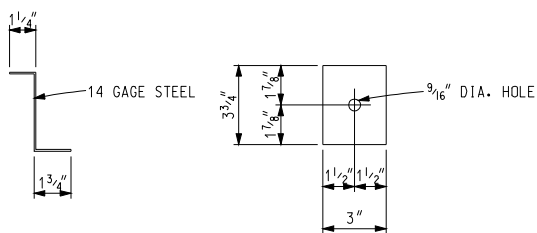

Z-BRACKET DETAIL

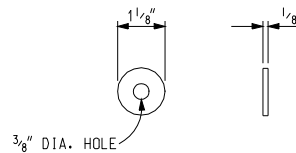

OPTIONAL NYLON WASHER

Other temporary sign supports meeting current NCHRP crash worthy criteria can be found on the FHWA Safety website at http://safety.fhwa.dot.gov/roadway_dept/road_hardware/wzd.htm

NOT TO SCALE

| | | | | |
|--|--|-----------|-----------|-----------------|
| MICHIGAN DEPARTMENT OF TRANSPORTATION BUREAU OF HIGHWAYS DELIVERY STANDARD PLAN | (SPECIAL DETAIL) FHWA APPROVAL DATE | 9/22/09 | WZD-125-E | SHEET 2 of 3 |
| File: T&S/Typ/Signs/WorkZones/wzd 125 d | Rev. 09/22/09 PJ | PLAN DATE | | |

NOTE: THE ORIGINAL SIGNED COPY IS KEPT ON FILE AT THE MICHIGAN DEPARTMENT OF TRANSPORTATION.

- PLASTIC DRUM
- ▲▲▲ PROPOSED TYPE III BARRICADE
- △△△ EXISTING TYPE III BARRICADE

SYMBOLS TO BE USED ON PLANS

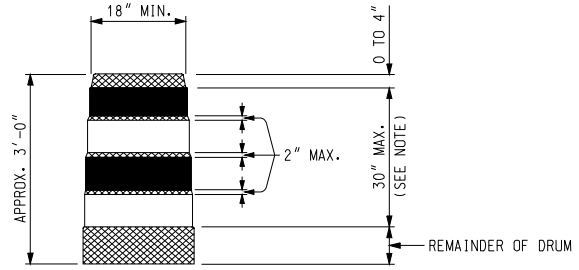

- REFLECTORIZED ORANGE
- REFLECTORIZED WHITE
- NON REFLECTORIZED ORANGE

NOTE:
 DRUMS SHALL HAVE AT LEAST 4 HORIZONTAL REFLECTORIZED STRIPES (2 ORANGE AND 2 WHITE) OF 6" UNIFORM WIDTH, ALTERNATING IN COLOR WITH THE TOPMOST REFLECTORIZED STRIPE BEING ORANGE. NON REFLECTORIZED SPACES BETWEEN THE HORIZONTAL REFLECTORIZED ORANGE AND WHITE STRIPES SHALL BE ORANGE IN COLOR AND EQUAL IN WIDTH.

PLASTIC DRUM

NOTES:

2" PERFORATED SQUARE STEEL TUBES MAY BE USED TO FABRICATE THE HORIZONTAL BASE OF THE TYPE III BARRICADE.

WARNING LIGHTS SHALL BE PLACED ACCORDING TO THE CURRENT STANDARD SPECIFICATIONS FOR CONSTRUCTION AND ALL OTHER PROVISIONS IN THE CONTRACT WHEN THEY ARE USED ON TYPE III BARRICADES.

SEE ROAD STANDARD PLANS R-113-SERIES FOR TEMPORARY CROSSOVERS FOR DIVIDED ROADWAY, AND R-126-SERIES FOR TYPICAL LOCATION AND SPACING OF PLASTIC DRUMS FOR PLACEMENT OF TEMPORARY CONCRETE BARRIER.

SIGNS, BARRICADES, AND PLASTIC DRUMS SHALL BE FACED WITH PRESSURE-SENSITIVE REFLECTIVE SHEETING ACCORDING TO THE CURRENT STANDARD SPECIFICATIONS FOR CONSTRUCTION.

SANDBAGS SHALL BE USED WHEN SUPPLEMENTAL WEIGHTS ARE REQUIRED TO ACHIEVE STABILITY OF THE BARRICADE. THE SANDBAGS SHALL BE PLACED SO THEY WILL NOT COVER OR OBSTRUCT ANY REFLECTIVE PORTION OF THE TRAFFIC CONTROL DEVICE.

NOT TO SCALE

| | | | | |
|--|--|-----------|-----------|-----------------|
| MICHIGAN DEPARTMENT OF TRANSPORTATION BUREAU OF HIGHWAYS DELIVERY STANDARD PLAN | (SPECIAL DETAIL) FHWA APPROVAL DATE | 9/22/09 | WZD-125-E | SHEET 3 of 3 |
| File: T&S/Typ/Signs/WorkZones/wzd 125 d | Rev. 09/22/09 PJ | PLAN DATE | | |

NOTE: THE ORIGINAL SIGNED COPY IS KEPT ON FILE AT THE MICHIGAN DEPARTMENT OF TRANSPORTATION.

CITY OF OWOSSO
SPECIAL PROVISION
FOR
WATER MAIN INSTALLATION

Page 1 of 15

10/30/2019

DESCRIPTION

This work shall consist of installing water main and appurtenances in accordance with the plans, this special provision, AWWA, MDEQ, and the MDOT 2012 Standard Plans and Specifications. This shall include all labor, equipment, and materials to complete the work.

For the protection of underground utilities and in conformance with Public Act 174 of 2013, the Contractor shall contract the Miss Dig system, Inc. by phone at 811 or 800-482-7171 or via the web at either elocate.missdig.org for single address or rte.missdig.org, a minimum of 3 business days prior to excavation, excluding weekends and holidays.

The Department of Public Works can assist the Contractor in locating existing water service leads and mains. All removed valves and hydrants shall be salvaged and returned to the Department of Public Works.

The Contractor shall contact the Engineer to schedule work interfering with existing water service. Temporary shut off of service shall be obtained from the Department of Public Services.

A service charge of \$1,000 will be required at time of permit application. This fee includes the minimum charge of \$50 for 5,000 bulk gallons of water, plus additional charges of \$10 per 1,000 gallons consumed in excess of the minimum quantity. Owosso Water System personnel will attach a water meter and RPZ backflow preventer to the hydrant for Contractor use. If the water meter and RPZ is returned in good operating condition, the Contractor will receive a \$450 refund, less additional water consumed in excess of minimum quantity.

MATERIALS

All materials supplied by the Contractor shall be new, meeting minimum specifications of American Water Works Association (AWWA) Standards, and special provisions as delineated by the City of Owosso. All materials shall be lead free as defined by the USEPA Safe Drinking Water Act, in that; "All pipes, pipe fittings, plumbing fittings, and fixtures that are used for potable water must comply with the lead free requirement and must bear the mark NSF/ANSI Standard 61, Annex G or NSF 61-G."

Michigan and United States of America products shall be used whenever possible.

Pipe

Water main constructed of PVC pipe shall conform to AWWA C900/C909 standards. C909 PVC pipe shall be used for open trench cut installations. C900 PVC fused pipe shall be used for

CITY OF OWOSSO
SPECIAL PROVISION
FOR
WATER MAIN INSTALLATION

Page 2 of 15

10/30/2019

trenchless installations. Pipe shall meet both NSF/ANSI Standard 61 and NSF/ANSI Standard 14. PVC pipe shall have a ratio of diameter to wall thickness of 18, unless noted otherwise on the plans or in the proposal.

Water main constructed of ductile iron pipe shall conform to AWWA C151/C600. Pipe shall meet Thickness Class 52 and Pressure Class 350. Ductile iron pipe shall be lined with a cement mortar and bituminous seal coat in accordance with AWWA C104.

Pipe manufacturer and class shall be marked on each length of pipe.

Pipe, fittings, joints, and fire hydrants in soils contaminated with volatile organic compounds, as determined in the field by the Engineer, shall require the use of Linear Low Density Polyethylene black (8-mil) Poly Wrap ANSI/AWWA C105/A21.5, ASTM D882, for up to one foot of finished grade.

Fittings/Joints

Joints shall be push-on type with elastomeric gaskets meeting the requirements of ASTM D3139/F477 or AWWA C111 and shall be provided with an electrical conductivity device.

Fittings shall be cast iron or ductile iron with mechanical joints and shall be in accordance with AWWA C153 / ANSI A21.53. Fittings shall be cement lined in accordance with ANSI/AWWA A21.4/C104 and rated for 250 psi, or more.

Following manufacturer's standards, mechanical joint restraint shall be required and shall be MEGALUG by EBAA Iron, or approved equal.

All mechanical joints and fittings requiring bolt-on fasteners shall use Blue Core Bolts.

Corrosion protective material as a barrier encasement in varying soil conditions shall be required. Use 1) Linear Low Density Polyethylene black (8-mil) Poly Wrap ANSI/AWWA C105/A21.5 ASTM D882, or 2) Sanchem, Inc. NO-OXG-ID GG-2 lubricant. Corotech coal tar epoxy is not permitted for use.

Ductile iron water main shall require the use of nitrile gaskets, and used in place of PVC pipe where hazardous soils exist..

Fire Hydrants

This item shall include the fire hydrant, an auxiliary valve (placed 3 feet from hydrant), valve box, connector pieces and the hydrant tee. These items shall be installed in accordance with the standard construction practices and the standard fire hydrant detail. Bends approved by Engineer

CITY OF OWOSSO
SPECIAL PROVISION
FOR
WATER MAIN INSTALLATION

Page 3 of 15

10/30/2019

and Department of Public Works may be added into the connection, but shall not be paid for separately. Extensions will also not be paid for separately.

All fire hydrants shall be manufacturer by East Jordan Iron Works (**EJIW**) **Stortz** 5BR250, 55726D, open right, with 5 1/2 foot depth of bury, and painted yellow, and manufactured in accordance with AWWA C502 specifications. Hydrants shall be provided as outlined in the details within the construction plans and below:

1. Dry-barrel fire hydrant traffic model or traffic flange type and 150 pound working pressure, compression type, and opening with the line pressure, with mechanical joints.
2. Fire hydrants shall be bronze mounted throughout with no iron-to-iron or steel contacts or threads. The operating stem in the base and valve seat shall be bronze.
3. All iron parts shall be of high strength grey iron conforming ASTM A126 Class B.
4. Fire hydrants shall have a 6-inch valve opening with a 6-inch mechanical joint inlet.
5. The minimum inside dimension shall be 8 inches.
6. The operating nut shall turn to the right to open and have a weather shield. The opening direction shall be plainly marked with an arrow near the operating nut showing the opening direction.
7. The operating nuts and nut nozzle caps shall be square and slightly tapered; and it shall be $1\frac{5}{16}$ " at its base and $1\frac{3}{16}$ " square at its end and $1\frac{1}{8}$ " long.
8. Fire hydrants shall be completely assembled at the factory with the drain opening sealed with a threaded plug.
9. Provide two fire hose connections and one pumper connection in accordance with municipality standards.
10. All nozzles shall be on a movable head on the hydrant barrel so that they may be rotated by changing the position of the top flange without removing the barrel.
11. Provide a Spring Cap Style McGard Fire Hydrant Lock for hydrant.
12. Provide proper length for installation at water main depth as indicated on the drawings.
13. All township fire hydrants (optional for in City of Owosso) shall have a concrete collar around the lower barrel, 12" below the ground line with 1" of expansion joint material between the hydrant barrel and collar, as directed by the Engineer. The collar shall be 6 inches thick with a diameter of at least 24 inches. Diameter will be as wide as necessary to reach undisturbed earth. Fire hydrants shall be tested to 300 pounds hydrostatic pressure from inlet side with valve in both open and closed position.
14. Fire hydrants to be painted yellow above the grade line, and black below the grade line. The 5" cap to be painted to AWWA color code based on municipal GPM flow data.
15. Fire hydrants shall be designed so one man can easily remove or replace the working parts without removing the main valve seat.
16. Fire hydrants flags are optional, and only upon request of municipality.
17. Hydrant valve operating nut shall be 2-inch.
18. Hydrant lead shall be six (6) inch with MEGALUG mechanical joint restraint.

CITY OF OWOSSO
SPECIAL PROVISION
FOR
WATER MAIN INSTALLATION

Page 4 of 15

10/30/2019

Gate Valves & Boxes

All gate valves shall be manufactured by East Jordan Iron Works (EJIW). All valves for use in water distribution systems shall be resilient seat, single wedge valves. The valves shall be in accordance with AWWA Specification C515 and shall also meet any supplemental requirements

or specifications of the municipality. Valves used on this project shall have mechanical joints with stainless steel bolts. The valves shall be manually operated with non-rising stems, iron body, bronze trim, and be furnished with a standard AWWA 2 inch square-operating nut. The wrench nut shall turn right (clockwise) to open with red top and shall be indicated by an arrow cast on the operating nut skirt. Valve stem risers are required for depths greater than 6'-6" and will not be paid for separately.

All valve boxes shall be manufactured by EJIW. The valve box shall be cast iron, 5-½ inch diameter, and three-piece adjustable screw type. Valve box extensions are required for depths greater than 6'-6" and will not be paid for separately. No. 6 round bases are required for gate valves up 8" in diameter and No. 160 oval bases for gate valves 10" and greater. The drop covers shall be stamped "water".

Curb Stops/Boxes, Taps, and Services

The water service piping shall be copper tubing, Type K, annealed, in accordance with ASTM B88. The size of tubing shall match the existing size of the water service being replaced. The fittings shall conform to ASTM B16.26, cast bronze. Joints of the copper tubing shall be flared. All water services to be constructed 90 degrees from water main to curb-stop/meter pit.

Taps – Ductile Iron Pipe:

1. For ¾ inch residential service tap, no saddle required. Use Ford F-1000-3-Q-NL, taped thread x CTS – QJ (Note: 1-inch minimum now required)
2. For 1 inch residential service tap, no saddle required. Use Ford #F-1000-4-Q-NL
3. For larger than 1 inch service tap, use Ford #F series as appropriate.

Taps – PVC Pipe:

1. Use Power Seal stainless steel saddle Model 3417AS for 4" to 24" diameter pipe.

Curb stops/boxes shall follow below:

1. Curb Stops shall be manufactured by Ford, Model #B-44-333-Q-NL for ¾ inch ball-stop, and Model #B-44-444-Q-NL for 1 inch ball-stop. Female thread x CTS – QJ or CTS – QJ x CTS – QJ.

CITY OF OWOSSO
SPECIAL PROVISION
FOR
WATER MAIN INSTALLATION

Page 5 of 15

10/30/2019

2. Curb Stops shall be 5' 6" deep.
3. Curb Stop Boxes shall be the Standard Buffalo patterns and all parts of the same, including extension sections, shall be interchangeable and fit up with corresponding parts of other Standard Buffalo pattern boxes.
4. Internal diameter of base shaft shall be 2-1/2 inches for (3/4 inch and 1 inch curb stop).
5. The boxes shall be cast iron, suitable coated to resist corrosion and the casting shall be smooth and free of any imperfections.
6. The covers shall overlap and fit outside the rim of the upper section, and they shall have a horseshoe-shaped groove in them to receive the bolt head and the word "water" embossed on the top surface.
7. All boxes shall be Tyler 6500 (2-1/2" Boxes) Series.

Tracer Wire and Boxes

Tracer wire shall be #10 AWG polyethylene coated steel core copper wire, attached to pipe by tape or other approved means, and manufactured by Copperhead Industries, LLC – Copperhead Reinforced Tracer Wire, or equal. Tracer wire connectors must contain a dielectric waterproof and corrosion proof sealant, lock shut, and be color coded blue. (See MRWA Detail as Attached)

Tracer wire boxes shall be magnetized, with a direct connection to tracer wire without removing the cover, be color coded, and have a locking cover. Boxes shall be installed at every fire hydrant isolation valve (separate from the valve riser), and at every distribution water main isolation valve (separate from the valve riser) and shall be Copperhead Industries, LLC – Snake-Pit Magnetized Tracer Box, or equal.

CONSTRUCTION METHODS

Excavation

The Contractor shall excavate all material to the depths necessary to construct the water main as shown on the plans. Excavation shall include the removal of rock, dirt, abandoned pipelines, old foundations, stumps and roots and similar materials encountered. Excavation, of whatever material encountered, shall be included in the contract unit prices for water main installation and will not be paid for separately. All excavated material shall be contractor responsibility for removal and disposal. Pavement removal and restoration will be paid for at the contract unit prices for the appropriate item in accordance with the Standard Specifications and Supplemental Specifications.

Excavated material that is suitable for backfill material shall be neatly piled adjacent to the excavation so as to prevent cave-ins of the excavation and damage to adjacent trees, shrubs, fences, and other property.

CITY OF OWOSSO
SPECIAL PROVISION
FOR
WATER MAIN INSTALLATION

Page 6 of 15

10/30/2019

The excavated area shall be kept free of water at all times. Sheeting and shoring shall be provided if necessary for the protection of the workers.

Excavated material that is not to be used as backfill shall be disposed of by the Contractor.

Backfilling shall follow immediately behind trench excavation and pipe laying operations. In no case shall more than 100 ft. of trench excavation be open at any one time. Any excavation left open and unattended shall be protected with lighted Type III barricades and a "snow fence" constructed around the perimeter of the excavation.

The Contractor shall excavate to the depths required to construct the water main and appurtenances as described on the plans. For water main construction, trench excavation shall be to a depth sufficient to provide a 5' 6" cover over the top of the pipe and a minimum four-inch sand cushion below the pipe. Over excavation will be at the Contractor's expense. The trench width at a level of twelve inches above the pipe shall be a minimum of 36 inches in width or as directed by the Director of Public Services or his designee.

In areas where the proposed construction may interfere with existing utilities, additional excavation may be required to determine the exact location of said existing utilities. This work will be included within the water main pay items and no additional compensation will be due to the Contractor for this work.

In some cases, the plans call for removing an existing water main or sewer in order to construct a new water main. All gate valve boxes shall be removed to at least 3 feet below the pavement surface under the road and to at least 12 inches below the planned grade outside the road. When required by construction specifications, the Contractor shall remove said existing pipelines and gate valve boxes and dispose of them at his expense. Old gate valves pulled by Contractor shall be turned over to the City of Owosso for further disposition.

Abandoned Water Mains. Where abandoned in place/ground, open ends of an abandoned pipeline shall be capped with a metallic cap, flowable filled, and bulk headed with one course of brick and mortar. Removal, disposal, flowable filling, and bulk heading of pipelines to be abandoned are included in Cut and Plug Water Main pay item. The following exceptions apply:

- 4 inch abandoned mains not required for flowable filling material.
- 6 inch and larger abandoned mains will be priced out by Contractor for flowable filling material. Only the city of Owosso may waive flowable flow material requirement.

Abandoned Water Service Connections. Services no longer in use shall be abandoned at the curb-stop, with curb-stop in off position and buried. However, during street construction, abandoned services shall be removed back to the water main, with the corporation in the off position and capped, or the corporation removed entirely and replaced with a repair clamp.

CITY OF OWOSSO
SPECIAL PROVISION
FOR
WATER MAIN INSTALLATION

Page 7 of 15

10/30/2019

Pipe Handling

Pipe shall be handled in such a manner as to prevent the ends from splitting, damages to the protective coatings, and other undesirable conditions. Pipe shall not be dropped, skidded, or rolled into other conditions. Repairs to damaged pipe must be approved by the City Engineer or authorized representative.

Pipe Cutting

Pipe cutting shall be done in a neat and workmanlike manner without damage to the pipe or lining and as to leave a smooth end at right angles to the axis of the pipe. Cutting shall be done by an approved mechanical saw or cutter. Hydraulic squeeze cutters are not acceptable.

Pipe laying

Pipe located inside structures shall be rigidly supported.

Pipe laid underground shall be uniformly supported through its entire length on a minimum four-inch cushion of sand. A depression shall be carved out of the sand cushion to accommodate the pipe bells.

Pipe laid at a depth with less than 5 1/2 foot of cover, shall be wrapped in Linear Low Density Polyethylene black (8-mil) Poly Wrap ANSI/AWWA C105/A21.5 ASTM D882, and encased with minimum 2-inch thick rigid Styrofoam board top and sides of pipe.

Pipe shall be inspected for defects, debris, or dirt while suspended in a sling prior to lowering it into the trench. Defective pipe shall be removed from the project site immediately. Lumps, blisters, and excess coal tar coating shall be removed from inside the bell and outside the spigot. These areas shall be wire brushed and wiped clean with a dry oil-free rag. No debris, tools, clothing, or other materials shall be allowed in the pipe.

Pipe shall be laid in a dry trench with bell ends facing in the direction of laying. After placing a length of pipe in the trench, and after installing the gasket and applying the gasket lubricant, the spigot end shall be centered in the bell and the pipe pushed home and brought to the correct line and grade. The pipe shall be secured in place by tamping granular material Class II around it. Precautions shall be taken to prevent dirt from entering the joint space. A watertight plug shall be inserted in the open end(s) of the pipe to prevent water, dirt, animals, or other foreign matter from entering the pipe.

CITY OF OWOSSO
SPECIAL PROVISION
FOR
WATER MAIN INSTALLATION

Page 8 of 15

10/30/2019

When it is necessary to deflect pipe from a straight line, either horizontally or vertically, the deflection shall not exceed the following values:

| <u>Nominal Pipe Size (In.)</u> | <u>Mechanical Joint Maximum Deflection (In./18 ft. length)</u> |
|--|--|
| 8 | 20 |
| 12 | 18 |

Jointing

Mechanical joints shall be installed in accordance with the joint manufacturer's recommendations. Copies of such recommendations shall be furnished to the Engineer prior to the start of construction.

Thrust Blocking

Thrust blocking shall be placed to support water main components as follows:

- at Tee's
- at 90 degree bends
- at dead end water mains.

Backfilling

Backfilling shall be in accordance with the trench detail called for on the plans or as directed by the Engineer in accordance with the following:

Trench Detail G shall be used when part of the trench is within the 1 on 1 influence area of an existing or proposed roadway, sidewalk, driveway, building (or similar structure), or located within the right of way. The trench shall be backfilled with granular material Class II, in lifts of ten inches, and mechanically tamped to 95% of maximum unit weight.

Trench Detail F shall be used when the trench is not within the 1 on 1 influence area of a road or structure. The trench shall be backfilled with granular material Class III to a level of six inches above the top of the pipe and compacted to not less than 95% of maximum weight. The remaining portion of the trench shall be backfilled in twelve-inch lifts with suitable excavated material and compacted to at least 90% of maximum unit weight. Suitable excavated material used for backfill shall be free of rocks, debris, trees, stumps, broken concrete, and organic material. Backfill material shall not be saturated with water.

Where the proposed water main crosses under an existing utility, the proposed water main shall be deflected around the existing utility in accordance with the following:

CITY OF OWOSSO
SPECIAL PROVISION
FOR
WATER MAIN INSTALLATION

Page 9 of 15

10/30/2019

1. Maintain 5' 6" cover over top of proposed water main.
2. Maintain at least 18" of vertical separation and 10' horizontal separation between the outside of the proposed water main and the outside of a sewer, drain pipe, or catch basin. Where less than 18 inches of vertical separation, encase water main in a concrete or plastic pipe. Where 10 LF of horizontal separation cannot be achieved, a variance shall be requested of the MDEQ/EGLE District Engineer.
3. Maintain at least one foot vertical separation between the outside of the proposed water main and all other utilities other than a sewer, storm drain, or catch basin.
4. When crossing an existing sewer, drain pipe, or catch basin lead, construct the proposed water main so that its joints are equidistant from the utility being crossed.
5. For carrier pipes less than six (6) inches in diameter, the inside diameter of the casing pipe shall be at least two (2) inches greater than the largest outside diameter of the carrier pipe joints or couplings. For carrier pipe six (6) inches or greater in diameter, the inside diameter of the casing pipe shall be at least four (4) inches greater than the largest outside diameter of the carrier pipe joints or couplings.
6. Centering devices shall be used when inserting the carrier pipe into the casing pipe.
7. All casing pipe ends that are below ground level shall be constructed as to prevent leakage of any substance from the casing throughout its length. Each end of the casing shall require a sufficient seal to prevent the potential for leakage of any substance from the casing pipe. Grout fill is an acceptable method installed by pressure grouting. If used, the grout material shall consist of non-shrink sand cement slurry or approved equal, and sufficiently seal the casing pipe ends to the satisfaction of the Engineer.

Hydrants

Hydrants shall be located as shown on the plans and approved by the municipality. Use of bends in connection shall be approved by Engineer and municipality. Bury depth shall be a 5 1/2 foot minimum. Six (6) inch hydrant leads shall be ductile iron with MEGALUG mechanical joint restraint.

Valves

Valves shall be located as shown on the plans and approved by the municipality. Valves placed in location without approval will require that the Contractor correct the error at his own expense.

Valve setting shall be examined by the Contractor prior to lowering in the trench. Check all nuts and bolts to assure tightness.

Valves shall be installed with the valve closed, supported on two 2" x 6" x 18" hardwood blocks, and vertically plumb. The valve box shall be set plumb and its axis shall be in line with the stem. Valve boxes shall have the ability for future adjustments of up to 6 inches, above or below grade.

Two isolation gate valves shall be installed at each 3-way intersection, and a three valve configuration at each 4-way intersection.

CITY OF OWOSSO
SPECIAL PROVISION
FOR
WATER MAIN INSTALLATION

Page 10 of 15

10/30/2019

Isolation/gate valves should be located within each intersection for easy identification for the system operator. Spacing of these valves should be about 6 feet for quick and easy determination of directional isolation. As result, end points of new main/cross overs, shall be plugged, with a blow-off at each end point for appropriate disinfection & pressure testing. The new water main shall not be connected to the existing water main until pressure and disinfection testing has passed city requirements.

Reaction Backing

All tees and 90 degree bends, and other fittings subjected to unequal thrust shall be restrained using mechanical joint fittings with retainer glands on both sides of the bend or tee, and shall also be supported with thrust blocking. All 45 degree bends shall be restrained with mega lug fittings.

Boring and Jacking

1. Construct and maintain jacking/boring pits as required. Adequately clear site required for pits as needed to perform the work. Size pits for boring machine, frames, and reaction blocks, minimum 2 sections of pipe and with sufficient room for working. Provide steel safety ladder.
2. Locate pits such that no damage occurs to trees, poles (not specified for removal) or structures in the immediate area.
3. Construct pits with sheeting and bracing as required for proper support in accordance with O.S.H.A. Standards and as needed to sufficiently support reaction blocks.
4. Place crushed rock or approved bedding to sufficiently support equipment and protect pit floor.
5. A pushing or jacking frame shall be built and furnished to fit or match the end of the pipe to be jacked so that the pressure of the jacks will be evenly distributed over the end of the pipe.
6. The hydraulic jacks shall have sufficient power to apply a smooth and even pressure to move the pipe in place. Hammering or ramming of the pipe will not be allowed.
7. The pipe shall be jacked upgrade where possible.
8. The excavation shall be done within the inside of the pipe and shall not exceed 12" ahead of the pipe being jacked in place.
9. After each pipe section is in place the pipe shall be checked for correct grade and line. Pipe not meeting the correct grade and line shall be rejected and replaced.
10. Excavation at the top and sides may be approximately 1" greater than the outside periphery of the pipe.
11. The bottom of the excavation shall be accurately cut to line and grade.

CITY OF OWOSSO
SPECIAL PROVISION
FOR
WATER MAIN INSTALLATION

Page 11 of 15

10/30/2019

12. Adjoining sections of pipe sleeve shall be attached with a continuous weld. Connecting steel pipe to concrete shall be completed with a poured in place concrete collar with reinforcement.

HYDROSTATIC PRESSURE TEST

All new construction shall be subjected to a hydrostatic pressure test. Testing should be performed as soon as possible after construction on a section is complete.

The Contractor shall provide all equipment, materials, and labor necessary to perform the tests, including pumps, gauges, plugs, corporations, excavation and backfill, water, miscellaneous piping and fittings, and a means of measuring the volume of water lost.

The Contractor shall fill the main with water through hydrants or corporations. Air shall be bled off at the ends and at highpoints through corporations or hydrants. The Contractor shall plug all taps made solely for the pressure test by inserting brass plugs.

Water shall be added until hydrostatic pressure at highest point of the main is at least 150 psig.

The Engineer shall be notified two hours prior to testing and shall witness the test and determine the leakage over a two hour period.

Water shall be added as necessary throughout the two hour test period to maintain a uniform pressure of 150 psi, plus or minus 5 psi.

At the end of the two hour period, the total volume of water added to maintain the required test pressure will be determined and will be the actual leakage in a two hour period.

The allowable leakage rate will be determined by the following formula:

$$L = \frac{S * D * ((P)^{1/2})}{148,000}$$

Where:

- L = Total allowable leakage rate (gal/hr).
- S = **Total length of pipe tested, in feet.**
- D = Nominal inside pipe diameter (inches).
- P = Actual test pressure (p.s.i.g).
- ^{1/2} = Square Root of P

Maximum leakage for 8 inch pipe = 1.3 gallons per two hours per 100 joints.

CITY OF OWOSSO
SPECIAL PROVISION
FOR
WATER MAIN INSTALLATION

Page 12 of 15

10/30/2019

If actual leakage rate exceeds the allowable leakage rate, the Contractor at his own expense shall locate and repair the leak(s). Testing shall be repeated until satisfactory results are obtained.

The cost of pressure testing shall be included in the pay item for Water Main Pipe actually constructed.

STERILIZATION

General

1. All pipe and fittings connected to and forming a part of a potable water supply shall be sterilized in accordance with the AWWA Standard C651-14.
2. Generally, sampling taps shall be provided on the water main every five hundred (500) feet, in order to afford representative water testing and sample collection. When long transmission mains are constructed, without side connections, the distance between each tap may, at the discretion of the Engineer, be increased. In addition, blow off connections and sampling taps shall be provided at every endpoint of the water main to be tested. No connection to the existing potable water system will be allowed until the new water main is approved. In all instances, sampling taps shall be provided to collect a source sample and enough representative water samples for laboratory examination.

Preliminary Flushing

The main shall be flushed prior to sterilization as thoroughly as possible with water pressure and outlets available. The main shall be flushed from the north gate valve first with the south gate valve closed, the north valve shall then be closed and the south valve opened. After the flushing is completed the plug for the 8 inch tee shall be installed. The minimum velocity in the main shall be 3.0 fps. The flushing operation shall be done after the pressure test has been made.

Disinfecting

1. Before being placed in service, all mains and existing piping disturbed in any manner by the work shall be disinfected in accordance with the AWWA Standard C651-14. Drawing the water from existing piping or even lowering the water pressure more than one-half will constitute disturbances of the piping.
2. The disinfecting of water mains, valves and other appurtenances incorporated into the main construction shall be done in accordance with the AWWA Standard C651-14.

CITY OF OWOSSO
SPECIAL PROVISION
FOR
WATER MAIN INSTALLATION

3. During the disinfecting operation, valves, hydrants and other mechanical devices controlling the water shall be operated to permit full effectiveness of the disinfectant. Valves shall be manipulated so that the strong solution within the main being sterilized will not flow back into the supply line nor flow into mains already in service.
4. Dechlorination of chlorinated waters to surface water, storm sewer, or drain from hydrostatic testing and disinfection of new water mains, will be required prior to discharge unless discharged to a sanitary sewer system. ANSI/AWWA 655 Field Dechlorination provides methods and procedures for dechlorination of chlorinated water discharges.

Final Flushing and Tests

1. After the required period of retention has elapsed, the heavily chlorinated water shall be flushed out completely discharged until the replacement water throughout the length of the main shall, upon test, be proven comparable in quality to the water supply source. Heavy chlorinated water shall be discharged to a nearby sanitary sewer manhole if available, or a contractor provided holding tank for proper disposal.
2. When the water in the treated main shall have been proven comparable to that of the source, at least 2 safe bacteriological samples collected at least 24 hours apart must be obtained from every 500 feet sections of WM, must be obtained before placing each section WM section in service. . In addition, blow off connections and sampling taps shall be provided at every endpoint of the water main to be tested. No connection to the existing potable water system will be allowed until the new water main is approved. Samples shall be taken in the presence of the Department of Public Services. Under no circumstances shall such samples be collected from unsterilized hydrants and hose connections. Should the results of the bacteriological examination prove satisfactory, the main shall be placed in service. Should the initial disinfecting fail to result in approval, the disinfecting procedure shall be repeated until satisfactory results are obtained.
3. Bacteriological samples must be picked up by the **City of Owosso** and forwarded to an approved commercial/state/municipal laboratory, and paid by the Contractor. The City of Owosso may offer to provide this service with existing laboratory facilities.

The completed work of water main installation will be paid for at the contract unit prices for the actual quantity of the following contract items (pay items) actually constructed.

| <u>PAY ITEMS</u> | <u>PAY UNIT</u> |
|--|-----------------|
| 1 inch Copper Service Lead, Type "K", Modified | Feet |
| Water Main, C909 PVC, 12 inch, TB Detail F , Modified | Feet |
| Water Main, C909 PVC, 12 inch, TB Detail G , Modified | Feet |
| Water Main, C909 PVC, 8 inch, TB Detail G , Modified | Feet |
| Water Main, DI, 12 inch, TB Detail F , Modified | Feet |
| Water Main, DI, 12 inch, TB Detail G , Modified | Feet |

CITY OF OWOSSO
SPECIAL PROVISION
FOR
WATER MAIN INSTALLATION

Page 14 of 15

10/30/2019

| | |
|--|----------|
| Water Main, DI, 8 inch, TB Detail G , Modified | Feet |
| Water Main, Rem | Feet |
| Connect to Existing Water Main | Each |
| Curb Box, Stop, ¾ inch Corporation Stop and Connection, Modified | Each |
| Fire Hydrant and Valve Assembly | Each |
| Gate Valve and Box, 12 inch, Modified | Each |
| Gate Valve and Box, 8 inch, Modified | Each |
| Hydrant, Rem | Each |
| Water Main, 4 inch, Cut and Plug, Modified | Each |
| Water Main, 6 inch, Cut and Plug, Modified | Each |
| Water Main, 8 inch, Cut and Plug, Modified | Each |
| Testing and Chlorination of Water Main | Lump Sum |

Water main will be paid for at the contract unit price for the actual length of water main installed in-place, for the various sizes and trench details called for. The contract unit price includes all labor, equipment, and materials necessary for the construction of the water main, including excavation, disposal, pipe, fittings, tees, crosses, hydrant tees, bends, plugs, reducers, thrust blocking, connections to the existing mains, backfill, snow fencing and barricading, locating and protecting existing utilities, repair of defective work, and cleanup.

Water main will be measured horizontally in linear feet along the centerline of the main, including the length of valves, sleeves, and fittings. Measurements will begin and end at connections, plugs, or the centerline of a perpendicular pipeline.

Testing and Chlorination will be paid for at the contract price upon completion and acceptance of the proposed water main and all tie ins. The contract unit price includes all labor, equipment, and materials necessary for hydrostatic pressure testing, disinfecting, and bacteriological testing of the proposed water main and appurtenances.

Connections to Existing Water Main will be paid for at the contract unit price for each connection made. Payment will include all labor, equipment, and materials necessary to connect the proposed water main to existing water mains, including connections to oversized and undersized pipe. Additional payment will not be made for any/all necessary coordination with the Department of Public Services or any exploratory excavation that is required to connect the proposed water main to the existing water mains.

Fire hydrant and valve assembly with box will be paid for at the contract unit price for each assembly installed. Payment will include furnishing and installing the hydrant, valve, valve box, connection, and lead. Excavation, thrust blocking, and backfill are all incidental to the contract unit price for hydrant and valve assembly with box.

CITY OF OWOSSO
SPECIAL PROVISION
FOR
WATER MAIN INSTALLATION

Page 15 of 15

10/30/2019

Gate valves, of the size required will be paid for at the contract unit price for each installed. The price includes excavation, installation of manhole or box, removal of valve and box to be replaced, anchorage, and backfill.

Cutting and Plugging of Water Main will be paid for at the contract unit price for each cut and plug made and flowable fill. Payment will include all labor, equipment, and materials necessary to shore up the existing water main.

Glenn M. Chinaware
Director of Public Services & Utilities

Effective: 31 January 2018

Last update 30 October 2019

**SPECIAL PROVISION
FOR
HORIZONTAL DIRECTIONAL DRILLING**

PART 1 - GENERAL

1.01 SUMMARY:

- A. This Section includes the work required to install a carrier or casing pipe for underground utilities under an obstacle using the method commonly known as horizontal directional drilling (HDD), to the grades and alignments shown on the Drawings.

1.02 REFERENCES:

- A. ASTM - American Society of Testing Materials, *Latest Edition*.
- B. PPI - Plastics Pipe Institute
- C. AWWA - American Water Works Association
- D. ANSI - American National Standards Institute

1.03 GENERAL REQUIREMENTS:

- A. The CONTRACTOR shall be responsible for the method of construction, the stability and accuracy of the drilled and reamed hole and pits constructed, and all costs for damages resulting from any failure thereof. The CONTRACTOR shall be solely responsible for the safety of the pits and related structures and personnel engaged in underground construction throughout the duration of the work.
- B. The CONTRACTOR's methods and schedule shall consider the overall project requirements and anticipated subsurface soils and groundwater conditions. The CONTRACTOR's selection of inadequate, inappropriate or inefficient equipment and methods will not be cause for adjustments to the contract price or contract time.
- C. The general dimensions, arrangement and details for the drilled hole and pits to be constructed shall be as needed to complete the required work.
- D. Methods of excavation, equipment and procedures for the directional drilling operation and pits shall be selected by the CONTRACTOR to provide adequate working space and clearances for the work to be performed.
- E. Pit excavation methods, groundwater control and pit support techniques shall be selected by the CONTRACTOR.
- F. The CONTRACTOR shall comply with the HDD Plan for Preventing and Controlling the Loss of Drilling Mud in Paragraph 3.15 SCHEDULES.

1.04 CONTRACTOR QUALIFICATIONS:

- A. The CONTRACTOR who will complete the work contained in this Section must be experienced in the type of work specified in this Section and must have successfully completed similar projects within the last three years.

- B. Personnel that will perform the work must be trained and experienced in the fabrication and installation of the materials and equipment, as well as being knowledgeable of the design and the reviewed shop drawings.
- C. At the ENGINEER's request, the CONTRACTOR responsible for the completion of the work contained in this Section shall submit a list of jobs successfully completed within the last three years. Information on each job must include the following:
 - 1. Date of Project
 - 2. Location
 - 3. Length of Directional Drill
 - 4. Size and Material of Pipe
 - 5. General CONTRACTOR's name, contact and phone number.
 - 6. OWNER's name, contact and phone number.
 - 7. Other information relevant to the successful completion of the project.

1.05 SAFETY:

- A. The CONTRACTOR shall become familiar with, and shall at all times conform to, all applicable codes, ordinances and laws in relation to the work required.
- B. Directional drilling equipment machine safety requirements shall include a common grounding system to prevent electrical shock in the event of a high voltage underground cable strike. The grounding system shall connect all pieces of interconnecting machinery; the drill, mud mixing system, drill power unit, drill rod trailer, operator's booth, worker grounding mats and any other interconnected equipment to a common ground. The drill shall be equipped with an "electrical strike" audible and visual warning system that shall notify the system operators of an electrical strike.
- C. Operators of the drill shall wear electrical shock protection equipment and operate from common grounding mats as required.

1.06 SUBMITTALS:

- A. Submit in accordance with SECTION 01 33 00 - SUBMITTALS.
- B. Proposed drill profile data including the minimum information listed below:
 - 1. Entrance angle
 - 2. Exit angle
 - 3. Minimum radius of curvature
 - 4. Depth of pipe every 50 feet
 - 5. Pilot hole diameter
 - 6. Back ream hole diameter
 - 7. Wet or dry pullback
 - 8. Estimated maximum pullback force
- C. Polyethylene pipe data including, but not limited to, the following:
 - 1. Manufacturer's brochures and catalog sheets
 - 2. Dimensions
 - a. Inside diameter
 - b. Outside diameter
 - c. Standard dimension ratio
 - d. Yield stress
- D. PVC to DI connection and restraint:

1. Manufacturer
 2. Product data sheet
 3. Dimension drawing
 4. Installation instructions
- E. Drilling Fluid:
1. Bentonite (or alternate):
 - a. Product manufacturer
 - b. Product data sheet
 - c. Mixing instructions
 2. Polymer:
 - a. Product manufacturer
 - b. Product data sheet
 - c. Mixing instructions
 - d. Material safety data sheet (MSDS)
- F. Drill Path Documentation upon completion: See Article 3.07.

1.07 DELIVERY, STORAGE AND HANDLING:

- A. Handle and store materials in a manner that will prevent:
1. Deterioration or damage
 2. Contamination with foreign matter
 3. Damage by weather or elements
- B. After the pipe is fused together and before it is pulled through the drilled hole, the CONTRACTOR shall be responsible to provide vehicular and emergency access to all properties affected by the fused pipeline. The CONTRACTOR shall be responsible to repair all damage to existing surface and site improvements damaged by the fused pipeline.

1.08 UTILITY PROTECTION:

- A. All underground utilities shown on the drawings are shown according to the best available information. It is the CONTRACTOR's responsibility to verify the location of all existing utilities prior to working in the area.
- B. All utilities are to remain in service and shall be protected by the CONTRACTOR from any damage as a result of his operations.
- C. Where utilities are encountered and are not shown on the drawings, the CONTRACTOR shall report them to the OWNER before proceeding with the work.
- D. All utilities damaged by the CONTRACTOR's activities shall be repaired or replaced by the CONTRACTOR without preventable delay. All costs to repair the utility including, but not limited to, materials, labor, inspection, testing and temporary service shall be born by the CONTRACTOR with no cost to the OWNER.
- E. All utilities in close proximity to the drill pilot bore, back ream or product pipe installation must be exposed in accordance with all codes, ordinances and regulations to ensure, by visual inspection, that the CONTRACTOR's work has not caused any damage to the utility or to the CONTRACTOR's work and adequate clearance between the utility and the CONTRACTOR's work is maintained.

1.09 APPLICABLE REGULATIONS:

- A. All work covered by this Section shall be performed in accordance with all applicable federal, state and local laws, regulations, codes and ordinances which pertain to such work, as well as the supplemental regulations contained in these specifications. If a conflict exists between any laws, regulations, codes or ordinances, the most stringent shall govern.

PART 2 - PRODUCTS

2.01 MATERIALS:

1. PVC Pipe: Polyvinyl-chloride Fusible (PVC) pipe shall be of a class and designation as shown on Drawings, with a DR of 18 to 14 or less compound designation Class No. 12454, ASTM-D1784. PVC pipe shall be in accordance with current AWWA Standard C-900 (4-12 inches).
 2. The pipe shall have a nominal diameter as indicated on the plans and a standard dimension ratio (SDR) of no greater than _____. The working pressure shall be rated at 160 psi.
 3. The CONTRACTOR is responsible for calculating loads placed on the pipe during its installation based on the CONTRACTOR's chosen means and methods of construction. It is the CONTRACTOR's responsibility to ensure the pipe will withstand all loadings placed on it during installation. If the pipe with dimensions given above will not withstand the installation loads, it is the CONTRACTOR's responsibility to size the pipe to withstand the installation loads.
 4. Manufacturers:
 - a. Phillips Driscopipe, Inc.
 - b. Chevron Chemical Company (Plexco)
 - c. or Engineer approved equal
- B. DRILLING FLUIDS
1. The CONTRACTOR must use a high quality Bentonite drilling fluid or equivalent to ensure hole stabilization, cuttings transport, bit and electronics cooling, and hole lubrication to reduce drag on the drill pipe and the product pipe. Oil-based drilling fluids or fluids containing additives that can contaminate the soil or ground water will not be considered acceptable substitutes. Composition of the drilling fluid must comply with all federal, state and local environmental regulations.
 2. Polymer used as lubrication in the drilling fluid is acceptable, if desired.
 3. Drilling fluids must be mixed with water that is free from significant solids and contamination. Potable water is acceptable. River water is acceptable provided no organic matter or soil particulates are mixed into the drilling fluid. It is the CONTRACTOR's responsibility to apply for and obtain any necessary permits for the procurement of drilling fluid water. It is also the CONTRACTOR's responsibility to pay permit application fees, metering charges or any other costs associated with drilling fluid mixing water.
- C. PVC TO DUCTILE IRON CONNECTION

1. A restrained connection between the PVC pipe and DI pipe shall be made with a self-restraining, fusible, molded PE3408 mechanical joint adapter meeting the requirements of ASTM D2513 and ANSI/AWWA C906 and manufactured by Central Plastics Company or approved equal. The mechanical joint adapter shall be of the same SDR rating as the pipe. Additional restraint shall be provided on the ductile iron pipe side of the connection point by restraining pipe joints for a distance of at least 150 feet. Additional restraint may be provided on the HDPE pipe side in the form of an PVC anchor ring encased in concrete or other approved methods.

D. TRACER WIRE:

1. The Contractor shall install, with the directionally drilled pipe, a 12 gauge copper clad steel locator wire with insulation suitable for direct burial. The tracer wire shall be as manufactured by Copperhead Industries, or equal. In rural areas, a test station shall be installed at approximately 1,000 foot intervals, near a fire hydrant or other structure that would fall closest to that interval. In built up urban areas, a station shall be provided at each intersection.

2.02 EQUIPMENT:

- A. The directional drilling equipment shall consist of a directional drilling rig of sufficient capacity to perform the bore and pullback the pipe; a drilling fluid mixing, delivery and recovery system of sufficient capacity to successfully complete the crossing; a drilling fluid recycling system to remove solids from the drilling fluid so that the fluid can be re-used; a magnetic guidance system to accurately guide boring operations; a vacuum truck of sufficient capacity to handle the drilling fluid volume; and trained and competent personnel to operate the system. All equipment shall be in good, safe operating condition with sufficient supplies, materials and spare parts on hand to maintain the system in good working order for the duration of this project.

PART 3 - EXECUTION

3.01 ALIGNMENT AND PROFILE OPTIONS:

- A. Alignment and profile shown on the drawings.
- B. An alternate alignment and profile developed by the CONTRACTOR with the following requirements:
 1. Alignment must be within easement(s) and right-of-way.
 2. Clearance between utilities is maintained.
 3. 15 foot minimum vertical distance between the drill path and the bottom of a river to prevent drilling fluid breakout.
 4. ENGINEER approved.

3.02 PIPE FUSION

- A. All pipe shall be joined with the "butt fusion" method in accordance with the pipe manufacturers recommendations. Socket fusion, extrusion welding, hot gas welding and mechanical connections are not acceptable.
- B. Butt fusion joining shall produce a joint of equal or greater tensile strength than the strength of the pipe.

3.03 DRILL ENTRANCE AND EXIT PITS

- A. The CONTRACTOR is responsible for the design and construction of the drill entrance and exit pits. Supports may be required to maintain safe working conditions. Ensure stability of the pit, minimize loosening, and minimize soil deterioration and disturbance of the surrounding ground.
- B. Entrance and exit pits must be contained in the easement(s) and right-of way.
- C. Drill entrance and exit pits must be maintained at minimum size to allow only the minimum amount of drilling fluid storage prior to transfer to mud recycling or processing system or for removal from the site.
- D. Drilling fluid will not be allowed to freely flow on the site or around the entrance or exit pits. Fluid spilled must be removed as soon as possible and the ground restored to original condition.
- E. Pits must be shored to OSHA standard if workers are required to enter the pits for any reason.

3.04 DRILL ENTRANCE AND EXIT ANGLES

- A. Entrance and exit angles of the drill can be whatever the CONTRACTOR desires such that the elevation profile maintains adequate ground cover to ensure no drilling fluid breakout occurs and that ground exit occurs within the designated easement(s) or right-of-way. The CONTRACTOR is responsible for ensuring that entrance and exit angles ensure pullback forces do not exceed 5% strain on the polyethylene pipe.

3.05 GUIDANCE SYSTEM

- A. The guidance system must have the capability of measuring inclination, roll and azimuth. The guidance system must have an independent means to ensure the accuracy of the installation. The CONTRACTOR will demonstrate a viable method to eliminate accumulated error due to the inclinometer (pitch or accelerometer). The guidance system will be capable of generating a plot of the borehole survey for the purpose of an as-built drawing. The guidance system must meet the following specifications:

| | | |
|--------------|----------|--------------|
| Inclination: | Range | -90° to +90° |
| | Accuracy | 0.2° |
| Azimuth: | Range | 0° to 360° |
| | Accuracy | 0.5° |
| Roll: | Range | 0° to 360° |
| | Accuracy | 0.2° |

3.06 PILOT HOLE TOLERANCES

- A. The pilot hole shall be drilled along the agreed-to alignment and profile with the following tolerances:
 1. Vertical
 - a. Plus 4 feet (deeper or additional ground cover).
 - b. Minus 1 foot (shallower or reduced ground cover), except that the resulting pipe cover shall not be less than specified or indicated on the plans.
 2. Horizontal
 - a. Plus or minus 2.5 feet.
 3. Curve radius

- a. Curve radius shall not exceed the pipe manufacturer's recommendations and that of the drilling equipment.

3.07 DRILL PATH DOCUMENTATION

- A. The CONTRACTOR is responsible for maintaining drilling logs that provide drill path data every 25 feet along the drill path. Information logged every 25 feet will, at a minimum, include the following:
 - 1. Pilot hole
 - a. Distance out or station
 - b. Depth below a known ground surface elevation
 - c. Plus or minus (left or right) of alignment
 - d. Torque
 - e. Drill fluid flow rate
 - f. Time
 - 2. Back ream
 - a. Distance out or station
 - b. Pull back force
 - c. Torque
 - d. Drill fluid flow rate
 - e. Time

3.08 PIPE GOUGING

- A. The CONTRACTOR shall take every precaution to prevent gouging of the pipe prior to and during pipeline installation.
- B. It is expected some pipe gouging will occur during pullback. However, the constructed pipeline shall not have any gouges that are deeper than 10% of the pipe wall thickness. Pipe that has gouges greater than 10% of the pipe wall thickness will not be accepted.

3.09 INSTALLING PRODUCT PIPE

- A. After the pilot hole is completed, install a swivel to the reamer and commence pullback operations. Pre-reaming of the tunnel may be necessary and is at the option of the CONTRACTOR.
- B. Reaming diameter will not exceed 1.4 times the diameter of the product pipe being installed.
- C. Allow sufficient length of product pipe to extend past the termination point to allow connections to adjacent pipe sections or gate valves. Pulled pipes will be allowed 24 hours of stabilization prior to making tie-ins. The length of extra product pipe will be at the CONTRACTOR'S discretion.
- D. Install an AWWA C153 Mechanical Joint Adaptor, per the manufacturer's requirements, when connecting the pipe to a valve or hydrant.

3.10 YIELD STRESS

- A. The yield stress shall be calculated from the HDPE material submitted and the cross-sectional area of the pipe. The result will be the force at which the HDPE pipe will yield.
- B. The pullback force will be monitored throughout the pullback. At no time shall the equipment be operated to produce a pullback force that exceeds 75% of the yield force.

3.11 CLEANUP

- A. All excavated soil, soil cuttings and drilling fluid shall be the property of the CONTRACTOR. All material shall be disposed of in accordance with all laws, regulations, codes, ordinance and these specifications.
- B. Immediately upon completion of the work in this section, all rubbish and debris shall be removed from the job site. All construction equipment and implements of service shall be removed and the entire area involved shall be left in a neat, clean and acceptable condition.
- C. If a drilling fluid breakout should occur, the area shall be cleaned immediately and the surface washed and returned to original condition.
- D. Every precaution shall be implemented to prevent a drilling fluid breakout in the river. It is the CONTRACTOR's responsibility to conduct construction activities to prevent this occurrence. However, if a drilling fluid breakout occurs in the river, it is the CONTRACTOR's responsibility to clean up any resultant contamination. The CONTRACTOR is also responsible for any damage to property or the environment due to such a breakout.

3.12 HYDROSTATIC TESTING

- A. The pipe shall be hydrostatically tested before being connected to other piping systems. The pipe shall be tested independently of other hydrostatic tests.
- B. Hydrostatic testing will consist of filling the constructed pipeline with water taking care to bleed off trapped air. The CONTRACTOR shall pressurize the pipe to 150 psi for a minimum of 4 hours to give the pipe time to expand. During this initial 4 hours, make-up water shall be added as-needed to maintain the pressure within 5 psi of the specified pressure. At the end of the first 4 hours, the pipe shall be pressurized to the specified pressure and the test commences. The pipeline shall be maintained under the test pressure for a continuous period of between 1 and 3 hours, as determined by the ENGINEER, by pumping water into the line at frequent intervals. The volume of water so added to maintain pressure within 5 psi of the specified pressure shall be measured and considered to represent the "leakage" from the line during the interval.

The allowable "leakage" for the pipeline shall not exceed the allowances given in the following table.

| Nominal Pipe Size (In) | Allowable "Leakage" (Gal/100' of Pipe) | | |
|-----------------------------------|---|--------------------|--------------------|
| | 1-Hour Test | 2-Hour Test | 3-Hour Test |
| 3 | 0.10 | 0.15 | 0.25 |
| 4 | 0.13 | 0.25 | 0.40 |
| 6 | 0.30 | 0.60 | 0.90 |
| 8 | 0.50 | 1.0 | 1.5 |
| 10 | 0.75 | 1.3 | 2.1 |
| 11 | 1.0 | 2.0 | 3.0 |
| 12 | 1.1 | 2.3 | 3.4 |
| 14 | 1.4 | 2.8 | 4.2 |
| 16 | 1.7 | 3.3 | 5.0 |

| | | | |
|----|------|------|------|
| 18 | 2.2 | 4.3 | 6.5 |
| 20 | 2.8 | 5.5 | 8.0 |
| 22 | 3.5 | 7.0 | 10.5 |
| 24 | 4.5 | 8.9 | 13.3 |
| 28 | 5.5 | 11.1 | 16.8 |
| 32 | 7.0 | 14.3 | 21.5 |
| 36 | 9.0 | 18.0 | 27.0 |
| 40 | 11.0 | 22.0 | 33.0 |
| 48 | 15.0 | 27.0 | 43.0 |

It is understood that the pipe will continue to expand after the initial 4 hours under pressure and throughout the 1 to 3-hour test period. The allowable "leakage" presented in the table above accounts for this expansion and no additional allowable "leakage" will be considered.

- C. Under no circumstances shall the total time under the specified test pressure exceed 8 hours. If the test is not completed due to leakage, equipment failure, etc., the test shall be terminated and the pipeline shall be de-pressurized and permitted to "relax" for a minimum of 8 hours prior to the next testing sequences.
- D. If there are no visual leaks or significant pressure drops during the final test period, and the measured "leakage" is less than allowable, the pipeline passes the hydrostatic test.
- E. In the event that the "leakage", as determined by the ENGINEER, exceeds the specified allowable, the CONTRACTOR shall be responsible to repair or replace the pipeline until the pipeline passes the hydrostatic test, as determined by the ENGINEER.

3.13 TRACER WIRE

- A. The Contractor shall install, with the directionally drilled pipe, a 12 gauge copper clad steel locator wire with insulation suitable for direct burial. In rural areas, a test station shall be installed at approximately 1,000 foot intervals, near a fire hydrant or other structure that would fall closest to that interval. In built up urban areas, a station shall be provided at each intersection. Tracer wire shall be installed with the directionally drilled pipe.

MEASUREMENT AND PAYMENT.

The completed work items under HORIZONTAL DIRECTIONAL DRILLING will be measured in-place and paid for at the contract unit prices for the following contract items (pay items):

| Contract Item (Pay Item) | Pay Unit |
|--|----------|
| Water Main, C900 PVC, ___ inch, Bore | Foot |

Water Main, C900 PVC, ___ inch, Bore, of the type, size, and detail as specified will be measured in-place per Foot, along centerline of the pipe, with no deductions for fittings. The price shall be payment in full for furnishing all material, labor, and equipment required to perform the work specified herein and shown on the plans including:

- a. Flushing and disinfecting pipeline.
- b. Furnishing and installing the pipe, fittings, gaskets, bracing or sheeting, blocking, restraints, temporary blow-offs, removal of existing water main inside influence area of work, and all other miscellaneous items necessary to complete the work.
- c. No additional payment will be made for remedying an unsatisfactory hydrostatic test, including removing and replacing backfill.
- d. Dewatering operations, for trench or pipe, will not be paid for separately, but will be included as part of major contract pay items of this provision.
- e. The cost of excavation and proper disposal of material will not be paid for separately, but will be included as part of major contract pay items of this provision.
- f. The cost of furnishing and compacting backfill material will not be paid for separately, but will be included as part of major contract pay items of this provision.
- g. Removal or abandonment of existing water main, within the influence area of the proposed water main, will not be paid for separately, but will be included as part of major contract pay items of this provision

HORIZONTAL DIRECTIONAL DRILL PLAN
FOR
PREVENTING AND CONTROLLING THE LOSS OF DRILLING MUD

TABLE OF CONTENTS

SECTION

- 1.0 – INTRODUCTION
- 2.0 – HORIZONTAL DIRECTIONAL DRILLING PROCESS
- 3.0 – MONITORING PROCEDURES
- 4.0 – NOTIFICATION PROCEDURES
- 5.0 – CORRECTIVE ACTION AND CLEANUP
- 6.0 – ABANDONMENT

HORIZONTAL DIRECTIONAL DRILL PLAN

1.0 INTRODUCTION:

- A. This directional drill contingency plan provides specific procedures and steps to prevent and/or to contain inadvertent releases of drilling mud (also referred to as frac-outs) for waterbodies that are crossed using horizontal directional drilling (HDD) techniques.

2.0 HORIZONTAL DIRECTIONAL DRILLING PROCESS:

- A. Installation of a pipeline by HDD is generally accomplished in three stages. The first stage consists of directionally drilling a small-diameter pilot hole along a pre-determined path. The second stage enlarges this pilot hole to a diameter that will accommodate the pipeline. Numerous "reaming" passes will be necessary with each pass enlarging the diameter of the pilot hole incrementally. The third stage involves pulling the pipeline through the enlarged hole.

During the drilling of the pilot hole, directional control is achieved by using a non-rotating drill string with an asymmetrical leading edge. The asymmetry of the leading edge creates a steering bias, which allows the operator to control the direction of the drill bit. The actual path of the pilot hole is monitored during drilling by taking periodic readings of the inclination and azimuth. These readings are used to calculate the horizontal and vertical coordinates along the pilot holes relative to the initial entry point on the surface.

Once the pilot hole is complete, it is enlarged using reaming tools that are often custom-made for a particular diameter pipe or type of soil. The reamers are typically attached to the drill string at the exit point and are rotated and drawn to the drilling rig, thus enlarging the pilot hole with each pass. Pipe installation is accomplished by attaching a prefabricated pull section behind a reaming assembly at the exit point and pulling the entire assembly back to the drilling rig.

Ideally, horizontal directional drilling involves no disturbance to the bed or banks of a stream or wetland. However, it is possible that geologic irregularities could be encountered during drilling, and drilling could fail. This plan describes the potential for failure of horizontal directional drilling, the contingency methods that would be implemented in the event of inadvertent release of drilling fluids to water or land, and drill hole abandonment procedures.

The feasibility of the horizontal directional drill method primarily depends on the local geologic setting, as well as site topography and other surface features. For example, horizontal directional drilling may not be feasible in areas of glacial till or outwash interspersed with boulders and cobbles, highly fractured bedrock, or non-cohesive coarse sands and gravels. These formations increase the likelihood that drilling could fail due to refusal of the drill bit, continuous loss of drilling fluid through fractures or weak areas in the ground, or collapse of the bore hole in non-cohesive, unstable substrate.

Fortunately, surface characteristics at the proposed Project drill sites are generally favorable for HDD.

Also, subsurface geotechnical investigations indicate that conditions are favorable for horizontal directional drilling.

3.0 MONITORING PROCEDURES:

- A. The Project Engineer and construction personnel will continuously monitor operations during drilling activities. Monitoring activities will include:
- Visual inspection along the drill path, including monitoring the water body for evidence of a release.
 - Continuous examination of drilling fluid pressures and returns flows.

4.0 NOTIFICATION PROCEDURES

- A. If in the course of an inspection an inadvertent release is discovered, steps will be taken by construction personnel to contain the release as described in Section 5.0, Corrective Action and Cleanup.

If monitoring indicates an in-stream release, the Project Engineer will immediately notify the appropriate Federal and State agencies as soon as possible by telephone and/or facsimile of an in-stream release event, detailing the nature of the release and corrective actions being taken. The notified agencies will determine whether additional measures need to be implemented.

If a release occurs that may migrate downstream and affect water quality, downstream water users will be contacted.

5.0 CORRECTIVE ACTION AND CLEANUP

- A. By monitoring drilling operations continuously, it is intended to correct problems before they occur. In addition, containment equipment including earth-moving equipment, portable pumps, hand tools, sand, hay bales, silt fence, lumber, and a suction dredge will be readily available at the drill site. If a release does occur, the following measures will be implemented to stop or minimize the release and to clean it up:
- The drilling contractor will decide what modifications to make to the drilling technique or composition of drilling fluid (e.g., thickening of fluid by increasing bentonite content) to reduce or stop minor losses of drilling fluid.
 - If a minor bore path void is encountered during drilling, making a slight change in the direction of the bore path may avoid loss of circulation.
 - If the bore head becomes lodged resulting in loss of drilling pressure, the borehole may be sized by moving the bore head back and forth to dislodge the stuck materials.
 - If necessary, drilling operations will be reduced to assess the extent of the release and to implement other possible corrective actions.
 - If public health and safety are threatened, drilling fluid circulation pumps will be turned off. This measure will be taken as a last resort because it increases the potential for drill hole collapse resulting from loss of down-hole pressure.
 - If a land release is detected, the drilling crew will take immediate corrective action to contain the release and to prevent migration off site.
 - The contractor will construct pits and berms around the borehole entry point to contain inadvertent releases onto the ground.
 - Any drilling mud released into the pits will be pumped by contractor personnel into a mud-processing unit for recycling of drilling fluid and separation of cuttings.
 - Additional berms will be constructed around the bore pit as directed by the Project Engineer to prevent release materials from flowing into the water body.
 - If the amount of an on-land release does not allow practical collection, the affected area will be diluted with fresh water and allowed to dry. Steps will be taken (such as berm, silt fence, and/or hay bale installation) to prevent silt-laden water from flowing into the water body.

- If hand tools cannot contain a small on-land release, small collection sumps (less than 5 cubic yards) may be constructed to pump the released material into the mud processing system.
- Contractor HDD crews will immediately implement non-mechanized measures to contain the spread of drilling fluids, including the installation of hay bales or silt fence.
- Sump pumps or vacuum trucks will be used to remove and dispose of any drilling fluids.

6.0 ABANDONMENT

- A. If corrective actions do not prevent or control releases from occurring into the water body, the HDD Contractor may opt to re-drill the hole along a different alignment or suspend the Project altogether. In either case, the following procedures will be implemented to abandon the drill hole.
- The method for sealing the abandoned drill hole is to pump thickened drilling fluid into the hole as the drill assembly is extracted, and using cement grout to make a cap.
 - Closer to the surface of the hole(s) (within approximately 10 feet of the surface), a soil cap will be installed by filling with soil extracted during construction of the pit and berms.
 - The bore hole entry location will be graded by the contractor to its original grade and condition after the drill hole has been abandoned.

Materials

General

All trace wire and trace wire products shall be domestically manufactured in the U.S.A.

All trace wire shall have HDPE insulation intended for direct bury, color coated per APWA standard for the specific utility being marked.

Trace wire

- **Open Trench** - Trace wire shall be #10 AWG Copper Clad Steel, High Strength with minimum 450 lb. break load, with minimum 30 mil HDPE insulation thickness.
- **Directional Drilling/Boring** - Trace wire shall be #10 AWG Copper Clad Steel, Extra High Strength with minimum 1,150 lb. break load, with minimum 30 mil HDPE insulation thickness.
- **Trace wire – Pipe Bursting/Slip Lining** - Trace wire shall be 7 x 7 Stranded Copper Clad Steel, Extreme Strength with 4,700 lb. break load, with minimum 50 ml HDPE insulation thickness.

Connectors

- All mainline trace wires must be interconnected in intersections, at mainline tees and mainline crosses. At tees, the three wires shall be joined using a single 3-way lockable connector. At Crosses, the four wires shall be joined using a 4-way connector. Use of two 3-way connectors with a short jumper wire between them is an acceptable alternative.
- **Direct bury wire connectors** – shall include 3-way lockable connectors and mainline to lateral lug connectors specifically manufactured for use in underground trace wire installation. Connectors shall be dielectric silicon filled to seal out moisture and corrosion, and shall be installed in a manner so as to prevent any uninsulated wire exposure.
- Non locking friction fit, twist on or taped connectors are prohibited.

Termination/Access

- All trace wire termination points must utilize an approved trace wire access box (above ground access box or grade level/in-ground access box as applicable), specifically manufactured for this purpose.
- All grade level/in-ground access boxes shall be appropriately identified with “sewer” or “water” cast into the cap and be color coded.
- A minimum of 2 ft. of excess/slack wire is required in all trace wire access boxes after meeting final elevation.
- All trace wire access boxes must include a manually interruptible conductive/connective link between the terminal(s) for the trace wire connection and the terminal for the grounding anode wire connection.
- Grounding anode wire shall be connected to the identified (or bottom) terminal on all access boxes.

- **Service Laterals on public property** - Trace wire must terminate at an approved grade level/in-ground trace wire access box, located at the edge of the road right-of-way, and out of the roadway.
- **Service Laterals on private property** - Trace wire must terminate at an approved above-ground trace wire access box, affixed to the building exterior directly above where the utility enters the building, at an elevation not greater than 5 vertical feet above finished grade, or terminate at an approved grade level/in-ground trace wire access box, located within 2 linear feet of the building being served by the utility.
- **Hydrants** – Trace wire must terminate at an approved above-ground trace wire access box, properly affixed to the hydrant grade flange. (affixing with tape or plastic ties shall not be acceptable)
- **Long-runs, in excess of 500 linear feet without service laterals or hydrants** - Trace wire access must be provided utilizing an approved grade level/in-ground trace wire access box, located at the edge of the road right-of-way, and out of the roadway. The grade level/in-ground trace wire access box shall be delineated using a minimum 48" polyethylene marker post, color coded per APWA standard for the specific utility being marked.

Grounding

- Trace wire must be properly grounded at all dead ends/stubs
- Grounding of trace wire shall be achieved by use of a drive-in magnesium grounding anode rod with a minimum of 20ft of #14 red HDPE insulated copper clad steel wire connected to anode (minimum 0.5 lb.) specifically manufactured for this purpose, and buried at the same elevation as the utility.
- When grounding the trace wire at dead ends/stubs, the grounding anode shall be installed in a direction 180 degrees opposite of the trace wire, at the maximum possible distance.
- When grounding the trace wire in areas where the trace wire is continuous and neither the mainline trace wire or the grounding anode wire will be terminated at/above grade, install grounding anode directly beneath and in-line with the trace wire. Do not coil excess wire from grounding anode. In this installation method, the grounding anode wire shall be trimmed to an appropriate length before connecting to trace wire with a mainline to lateral lug connector.
- Where the anode wire will be connected to a trace wire access box, a minimum of 2 ft. of excess/slack wire is required after meeting final elevation.

Installation

General

- Trace wire installation shall be performed in such a manner that allows proper access for connection of line tracing equipment, proper locating of wire without loss or deterioration of low frequency (512Hz) signal for distances in excess of 1,000 linear feet, and without distortion of signal caused by multiple wires being installed in close proximity to one another.
- Trace wire systems must be installed as a single continuous wire, except where using approved connectors. No looping or coiling of wire is allowed.

- Any damage occurring during installation of the trace wire must be immediately repaired by removing the damaged wire, and installing a new section of wire with approved connectors. Taping and/or spray coating shall not be allowed.
- Trace wire shall be installed at the bottom half of the pipe and secured (taped/tied) at 5' intervals.
- Trace wire must be properly grounded as specified.
- Trace wire on all service laterals/stubs must terminate at an approved trace wire access box located directly above the utility, at the edge of the road right-of-way, but out of the roadway. (See Trace wire Termination/Access)
- At all mainline dead-ends, trace wire shall go to ground using an approved connection to a drive-in magnesium grounding anode rod, buried at the same depth as the trace wire. (See Grounding)
- Mainline trace wire shall not be connected to existing conductive pipes. Treat as a mainline dead-end, ground using an approved waterproof connection to a grounding anode buried at the same depth as the trace wire.
- All service lateral trace wires shall be a single wire, connected to the mainline trace wire using a mainline to lateral lug connector, installed without cutting/splicing the mainline trace wire.
- In occurrences where an existing trace wire is encountered on an existing utility that is being extended or tied into, the new trace wire and existing trace wire shall be connected using approved splice connectors, and shall be properly grounded at the splice location as specified.

Sanitary Sewer System

- A mainline trace wire must be installed, with all service lateral trace wires properly connected to the mainline trace wire, to ensure full tracing/locating capabilities from a single connection point.
- Lay mainline trace wire continuously, by-passing around the outside of manholes/structures on the North or East side.
- Trace wire on all sanitary service laterals must terminate at an approved trace wire access box color coded green and located directly above the service lateral at the edge of road right of way.

Water System

- A mainline trace wire must be installed, with all service lateral trace wires properly connected to the mainline trace wire, to ensure full tracing/locating capabilities from a single connection point.
- Lay mainline trace wire continuously, by-passing around the outside of valves and fittings on the North or East side.
- Trace wire on all water service laterals must terminate at an approved trace wire access box color coded blue and located directly above the service lateral at the edge of road right of way.
- Above-ground tracer wire access boxes will be installed on all fire hydrants.
- All conductive and non-conductive service lines shall include tracer wire.

Storm Sewer System

This section shall be included at the discretion of the facility owner.

- If the storm sewer system includes service laterals for connection of private drains and tile lines, it shall be specified the same as a sanitary sewer application.
- Lay mainline trace wire continuously, by-passing around the outside of manholes/structure on the North or East side.

Prohibited Products and Methods

The following products and methods shall not be allowed or acceptable

- Uninsulated trace wire
- Trace wire insulations other than HDPE
- Trace wires not domestically manufactured
- Non locking, friction fit, twist on or taped connectors
- Brass or copper ground rods
- Wire connections utilizing taping or spray-on waterproofing
- Looped wire or continuous wire installations, that has multiple wires laid side-by-side or in close proximity to one another
- Trace wire wrapped around the corresponding utility
- Brass fittings with trace wire connection lugs
- Wire terminations within the roadway, i.e. in valve boxes, cleanouts, manholes, etc.
- Connecting trace wire to existing conductive utilities

Testing

All new trace wire installations shall be located using typical low frequency (512Hz) line tracing equipment, witnessed by the contractor, engineer and facility owner as applicable, prior to acceptance of ownership.

This verification shall be performed upon completion of rough grading and again prior to final acceptance of the project.

Continuity testing in lieu of actual line tracing shall not be accepted.

Products

The following products have been deemed acceptable and appropriate. These products are a guide only to help you choose the correct applications for your tracer wire project.

- Copper clad Steel (CCS) trace wire
 - Open Trench – Copperhead #12 High Strength part # 1230-HS
 - Directional Drilling/Boring - Copperhead Extra High Strength part # 1245*EHS
 - Pipe Bursting/Slip Lining – Copperhead SoloShot Extreme Strength 7 x 7 Stranded part # PBX-50
- Connectors
 - Copperhead 3-way locking connector part # LSC1230*
 - DryConn 3- way Direct Bury Lug: Copperhead Part # 3WB-01
- Termination/Access
 - Non-Roadway access boxes applications: Trace wire access boxes Grade level Copperhead adjustable lite duty Part # LD14*TP
 - Concrete / Driveway access box applications: Trace wire access boxes Grade level Copperhead Part # CD14*TP 14”
 - Fire hydrant trace wire access box applications: Above ground two terminal with 1” conduit. Copperhead part # T3-75-F (Cobra T3 Test Station, denoting “F” includes mounting flange)
- Grounding
 - Drive in Magnesium Anode: Copperhead Part # ANO-1005 (1.5 lb)

Manufacture product options:

The information provided by Copperhead Industries gives you product options to help you choose the correct wire – termination/access points – connectors and grounding products. Other manufactures provide these products; this information is only a guide.

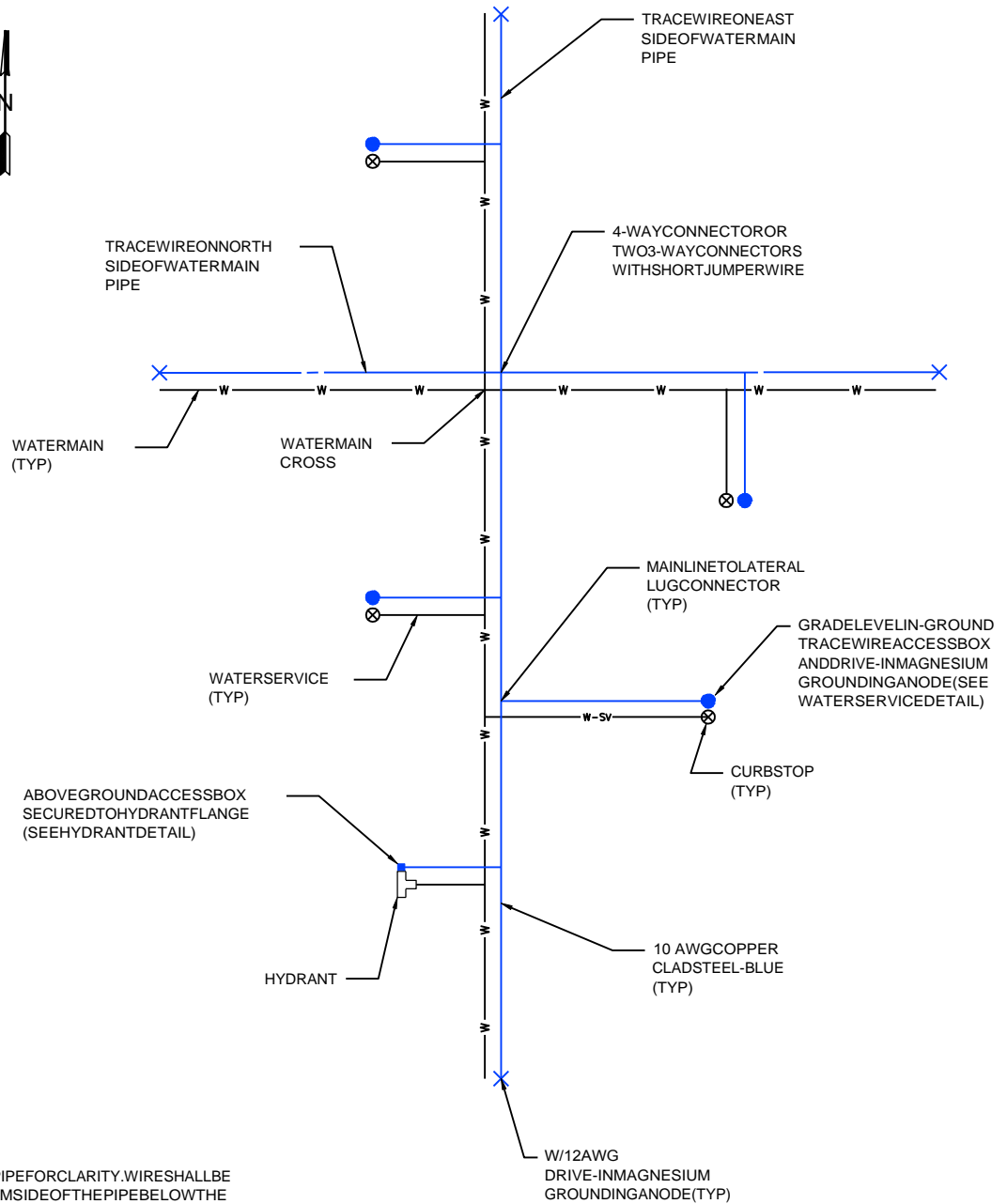

NOTES:

1. WIRES SHOWN AWAY FROM PIPE FOR CLARITY. WIRES SHALL BE INSTALLED ON THE BOTTOM SIDE OF THE PIPE BELOW THE SPRINGLINE. THE WIRES SHALL BE FASTENED TO THE PIPE WITH TAPE OR PLASTIC TIES AT 5' INTERVALS.

TRACEWIRE PLAN (WATER)

NOSCALE

MICHIGAN RURAL WATER ASSOCIATION
STANDARD DETAIL



TRACEWIRE
SAMPLE WATER PLAN

May 28, 2014

129

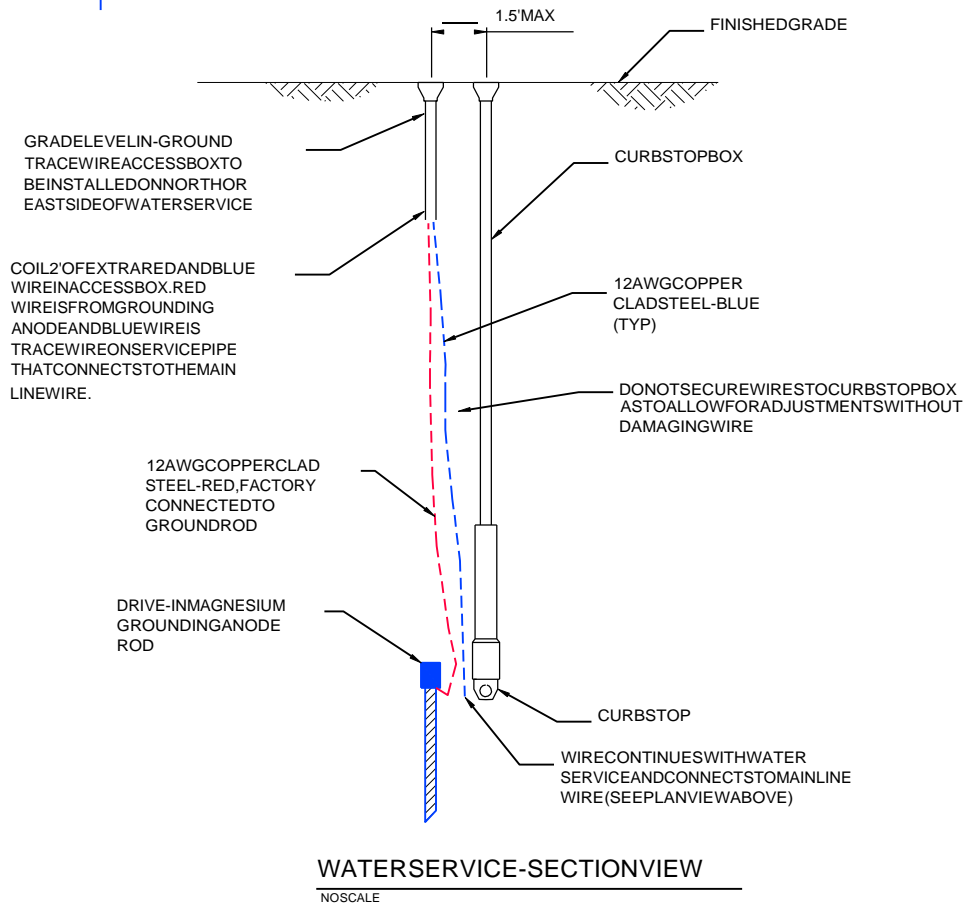
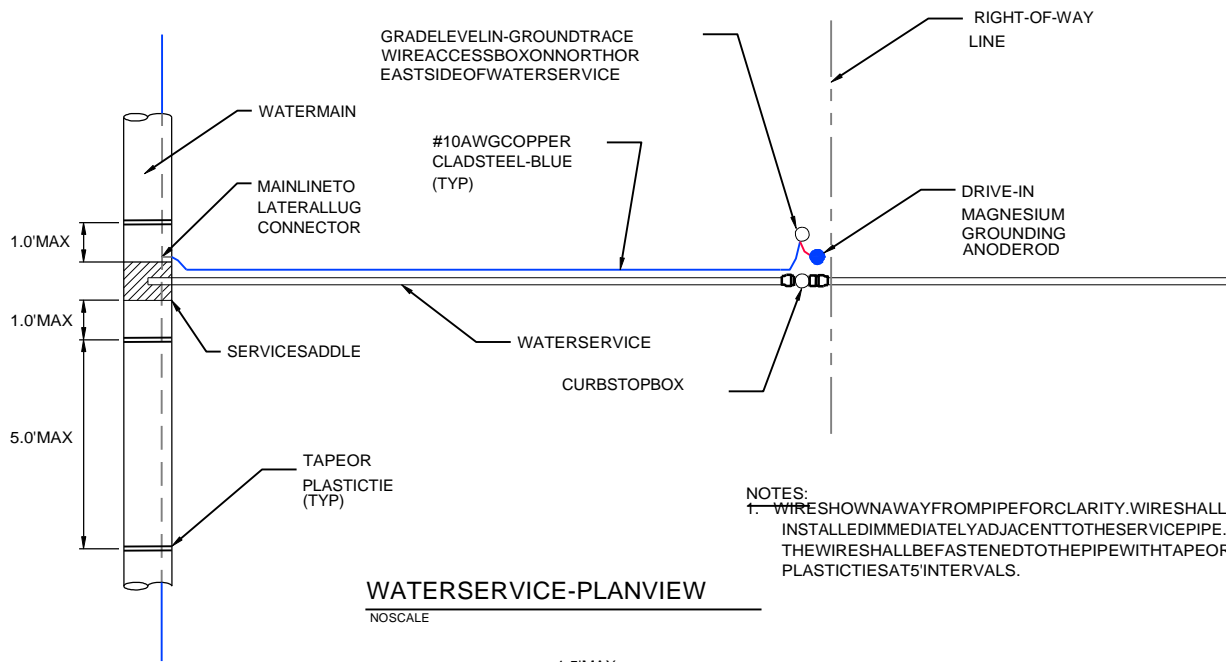

MICHIGAN RURAL WATER ASSOCIATION
STANDARD DETAIL

TRACE WIRE
WATER SERVICE DETAIL

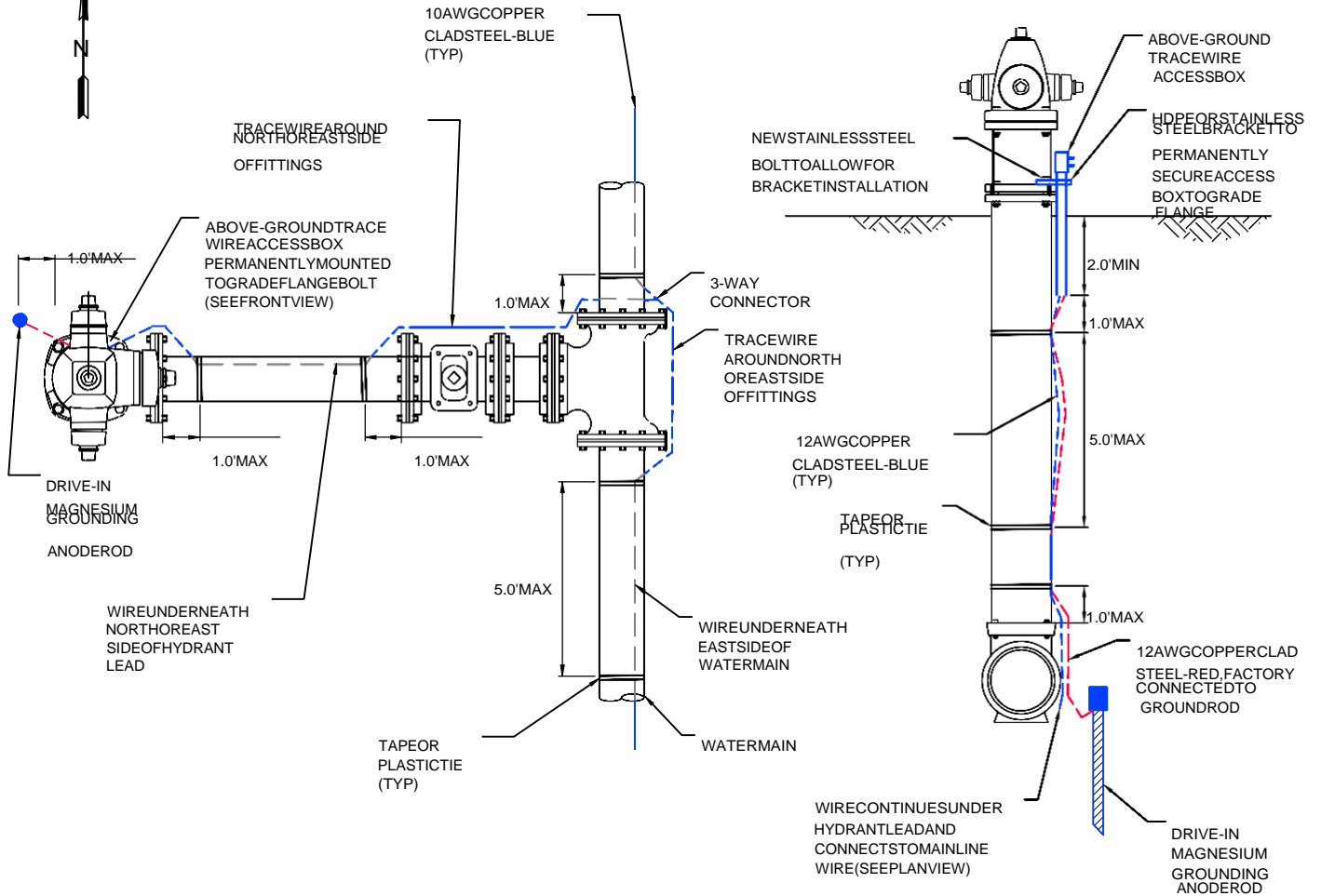

HYDRANT-PLAN VIEW

NOSCALE

HYDRANT-SECTION VIEW

NOSCALE



MICHIGAN
RURAL WATER ASSOCIATION
STANDARD DETAIL

TRACEWIRE
HYDRANT DETAIL

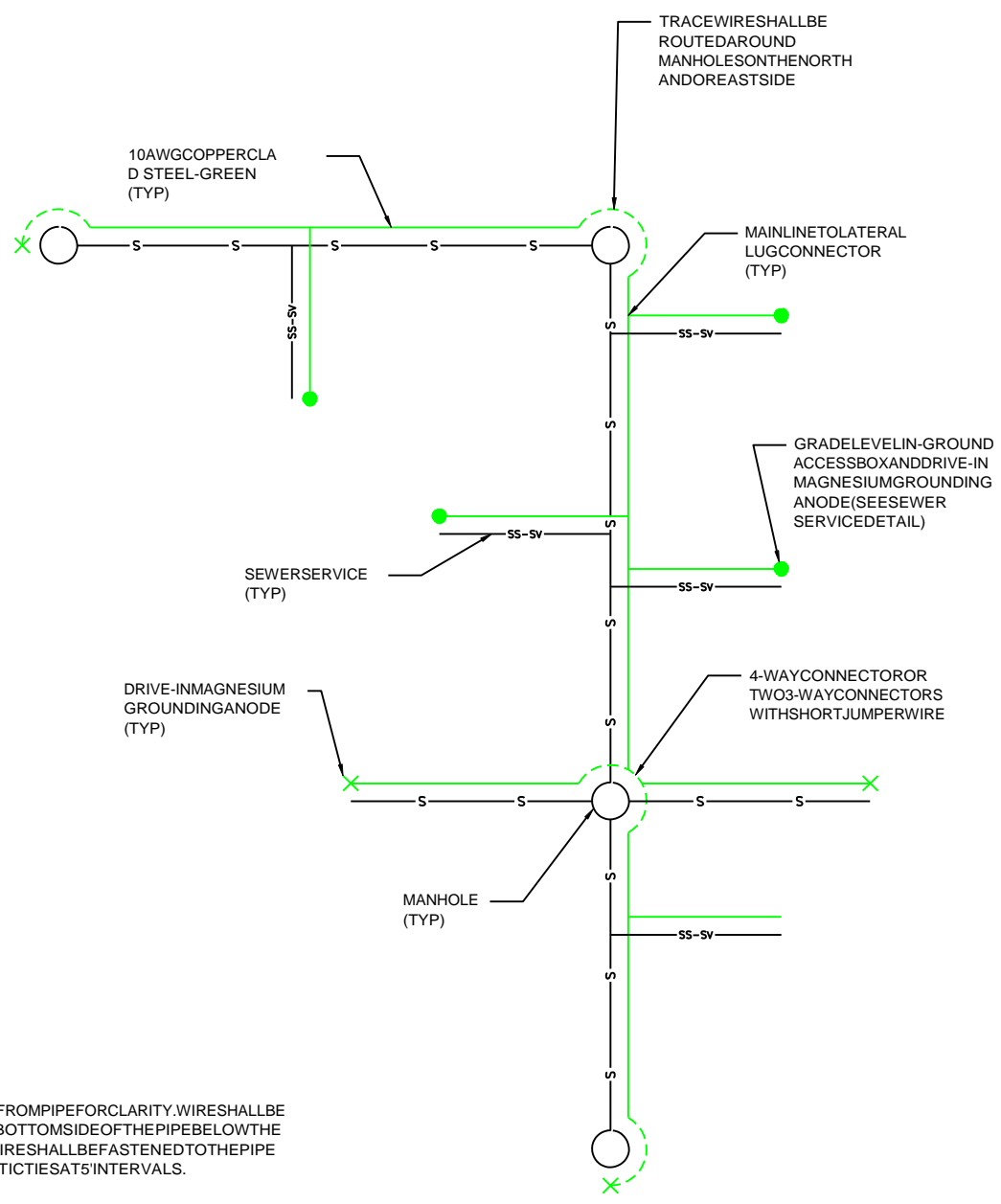
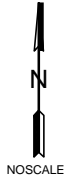

NOTES:
 1. WIRE SHOWN AWAY FROM PIPE FOR CLARITY. WIRE SHALL BE INSTALLED ON THE BOTTOM SIDE OF THE PIPE BELOW THE SPRINGLINE. THE WIRE SHALL BE FASTENED TO THE PIPE WITH TAPE OR PLASTIC TIES AT 5' INTERVALS.

TRACE WIRE PLAN (SEWER)
 NOSCALE



MICHIGAN RURAL WATER ASSOCIATION
 STANDARD DETAIL

TRACE WIRE
 SAMPLE SEWER PLAN

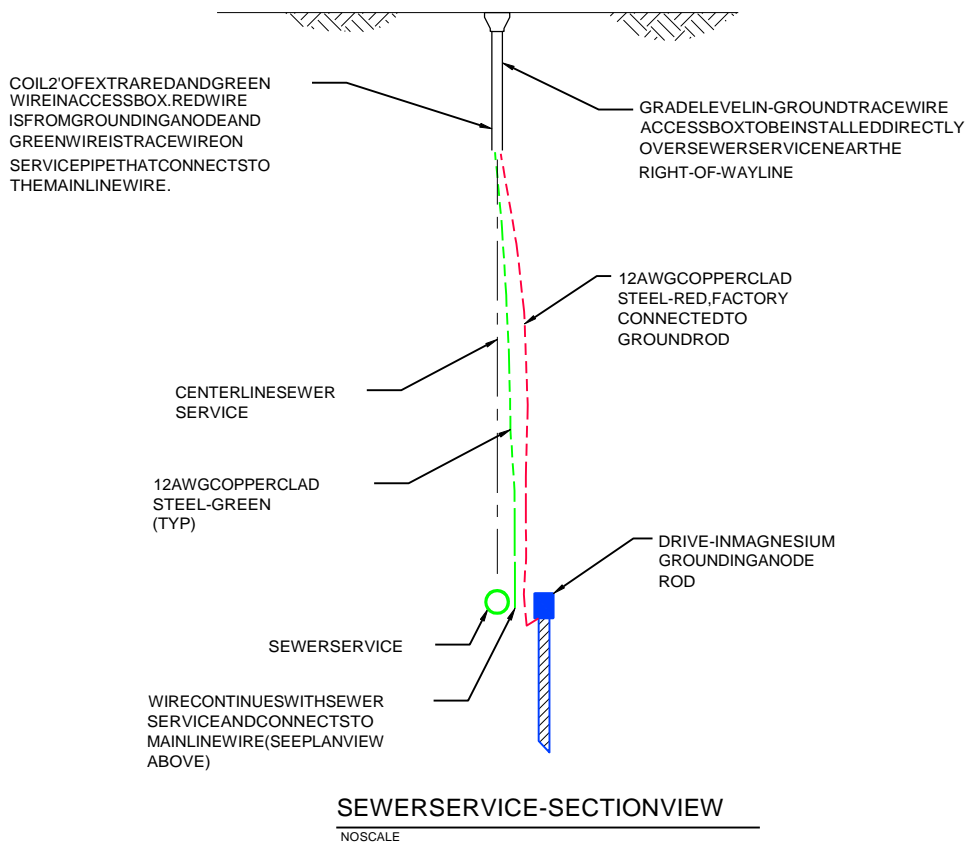
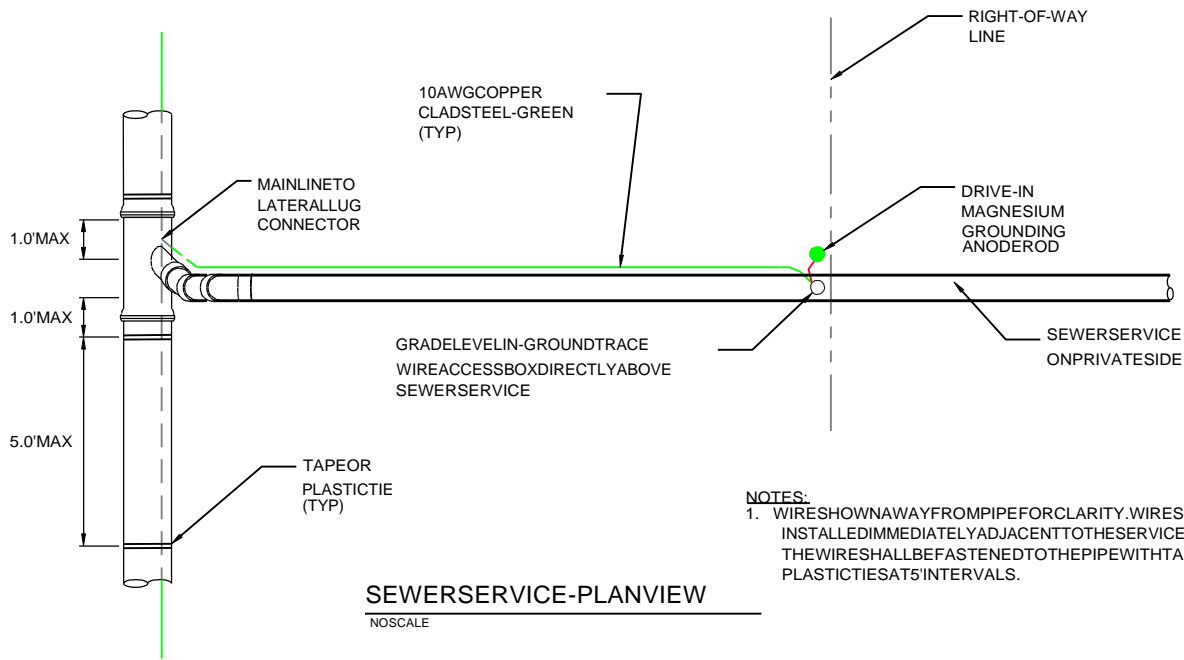

MICHIGAN RURAL WATER ASSOCIATION
STANDARD DETAIL

TRACEWIRE
SEWER SERVICE DETAIL

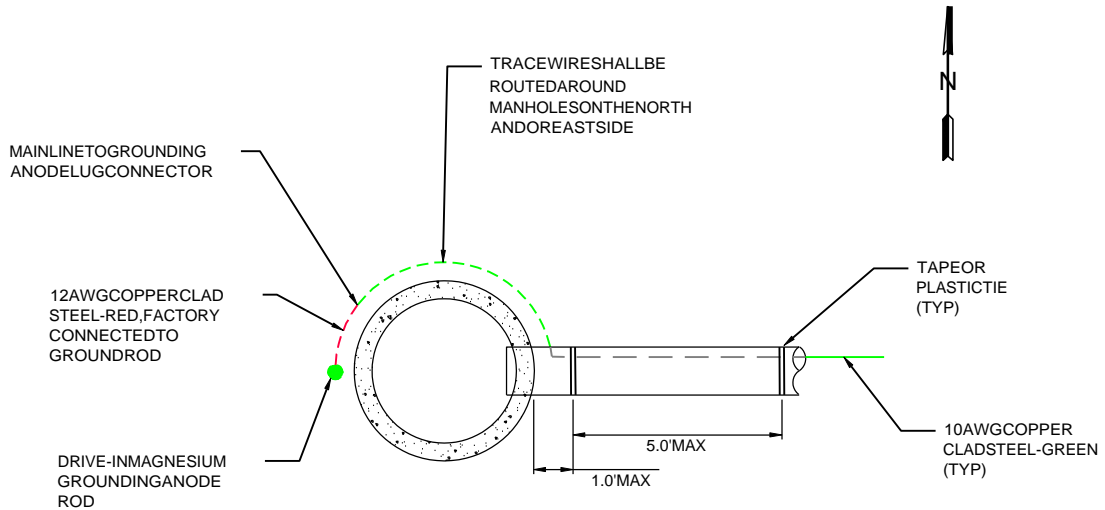

SEWERMANHOLE-PLANVIEW

NOSCALE

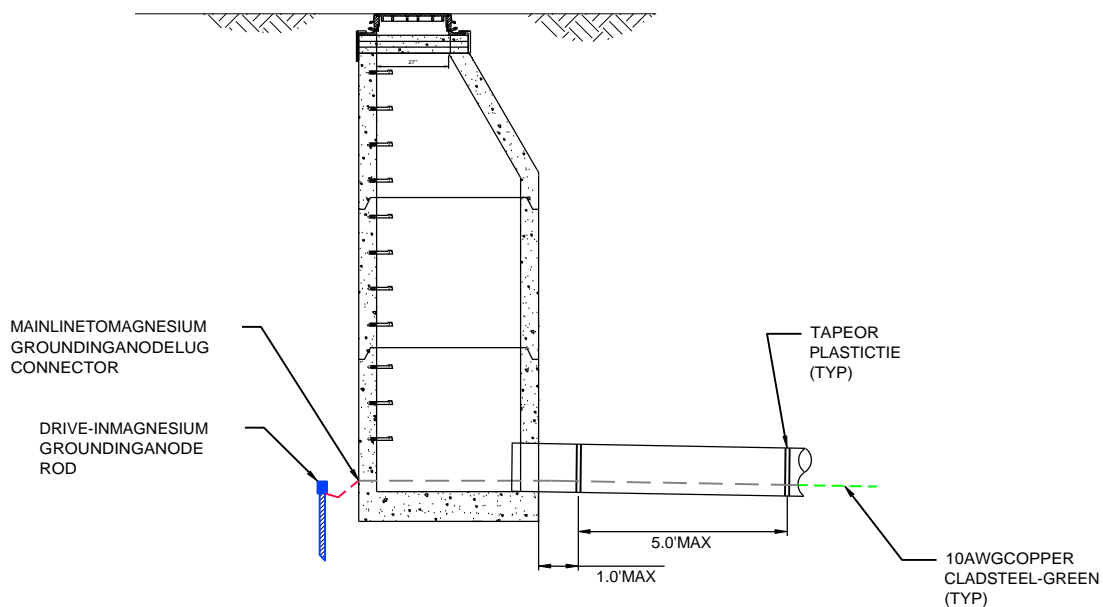

SEWERMANHOLE-SECTIONVIEW

NOSCALE

MICHIGAN RURAL WATER ASSOCIATION
STANDARD DETAIL



TRACEWIRE
SEWERMANHOLE DETAIL

May 28, 2014

134

SPECIAL PROVISION
FOR
WATER METER PIT, REM

City of Owosso/GC

1 of 1

Feb, 2018

Description

Work consists of removing existing meter pits as required in the Contract Documents and as directed by the City of Owosso and Engineer. This work includes furnishing all labor, equipment, and material required for the excavation, removal, salvaging, disposal of removed materials, backfilling, and all related work necessary to complete the water meter pit removal.

Materials

The City of Owosso shall have right of refusal on all meter pit materials. All other material shall be properly disposed of off site by the Contractor.

Construction

The City of Owosso will remove the meter and meter transmission unit (MTU) from the existing meter pit and reinstall in the new meter pit. The Contractor shall not remove or handle the existing water meter or the meter transmission unit.

Remove all portions of the existing meter pit once the new meter pit is installed and in service. The City of Owosso will inspect and advise on the materials desired to be salvaged during the removal of the existing meter and meter transmission unit. Salvaged materials will be picked up on site by the City of Owosso.

Measurement and Payment

The completed work, as described, will be measured and paid for at the contract unit price using the following contract pay item:

| Pay Item | Pay Unit |
|----------------------|-----------------|
| Water Meter Pit, Rem | Each |

Water Meter Pit, Rem will be measured in place by the unit Each and will be paid for at the contract unit price per Each, which price shall be payment in full for all labor, materials, and equipment necessary to complete this work. The unit price shall include coordinating meter removal and installation with City of Owosso; excavation; removal and disposal; providing, placing, and compacting backfill; and salvaging existing materials as directed.

Installation of new or replacement meter pit shall be paid for as Supply & Install Meter Pit, Complete.

SPECIAL PROVISION
FOR
SUPPLY & INSTALL METER PIT, COMPLETE

City of Owosso/GC

1 of 2

Feb, 2018

Description

Work consists of the installation of a new water meter pit or replacement of an existing water meter pit, as required in the Contract Documents and as directed by the City of Owosso and Engineer. This work includes furnishing all labor and equipment required for the excavation, installation, backfilling, and all related work necessary to complete the water meter pit installation.

The City of Owosso will provide the materials for the installation of the meter pit.

Existing meter pits may be eliminated with the meter being reinstalled inside the dwelling if determined feasible by the City of Owosso. All meter installs will be completed by the City.

Materials

Water meter pits are to be installed in lawn areas that are not subject to vehicular traffic.

Water meter pit materials are identified on the Typical Meter Pit Detail on the following page. The City of Owosso will provide all new materials for the installation of the meter pits.

Construction

Construct meter pit in accordance with the Typical Meter Pit Detail. The City of Owosso will pull the existing meter from the meter pit to be removed and reinstall the meter in the new pit. The Contractor shall not handle or install the water meter or the meter transmission unit (MTU).

The City of Owosso will assist with the installation of the first couple of meter pits.

Measurement and Payment

The completed work, as described, will be measured and paid for at the contract unit price using the following contract pay item:

| Pay Item | Pay Unit |
|--------------------------------------|-----------------|
| Supply & Install Meter Pit, Complete | Each |

Supply & Install Meter Pit, Complete will be measured in place by the unit Each and will be paid for at the contract unit price per Each, which price shall be payment in full for all labor, incidental material, and equipment necessary to complete this work. The unit price shall include verifying location of existing water service; notification of temporary service disruption; coordinating meter install with City of Owosso; picking up new materials from City of Owosso; excavation; bedding, installing meter pit; providing, placing, and compacting backfill; disposal of excess material; and adjustment of meter pit to finished grade. Materials to be provided by City of Owosso at no charge to Contractor.

Removal of existing meter pit shall be paid for as Water Meter Pit, Rem.

TYPICAL METER PIT DETAIL

NOT TO SCALE

DEQ
ALL PARTS MUST BE STAMPED
N L
FOR NO LEAD

FORD STOP
B-41-343-Q-NL 3/4" FEMALE x 1" CTS COMP
FORD METER RISER
71-33-81-33-NL 3/4" FEMALE x 3/4" MALE
71 SERIES

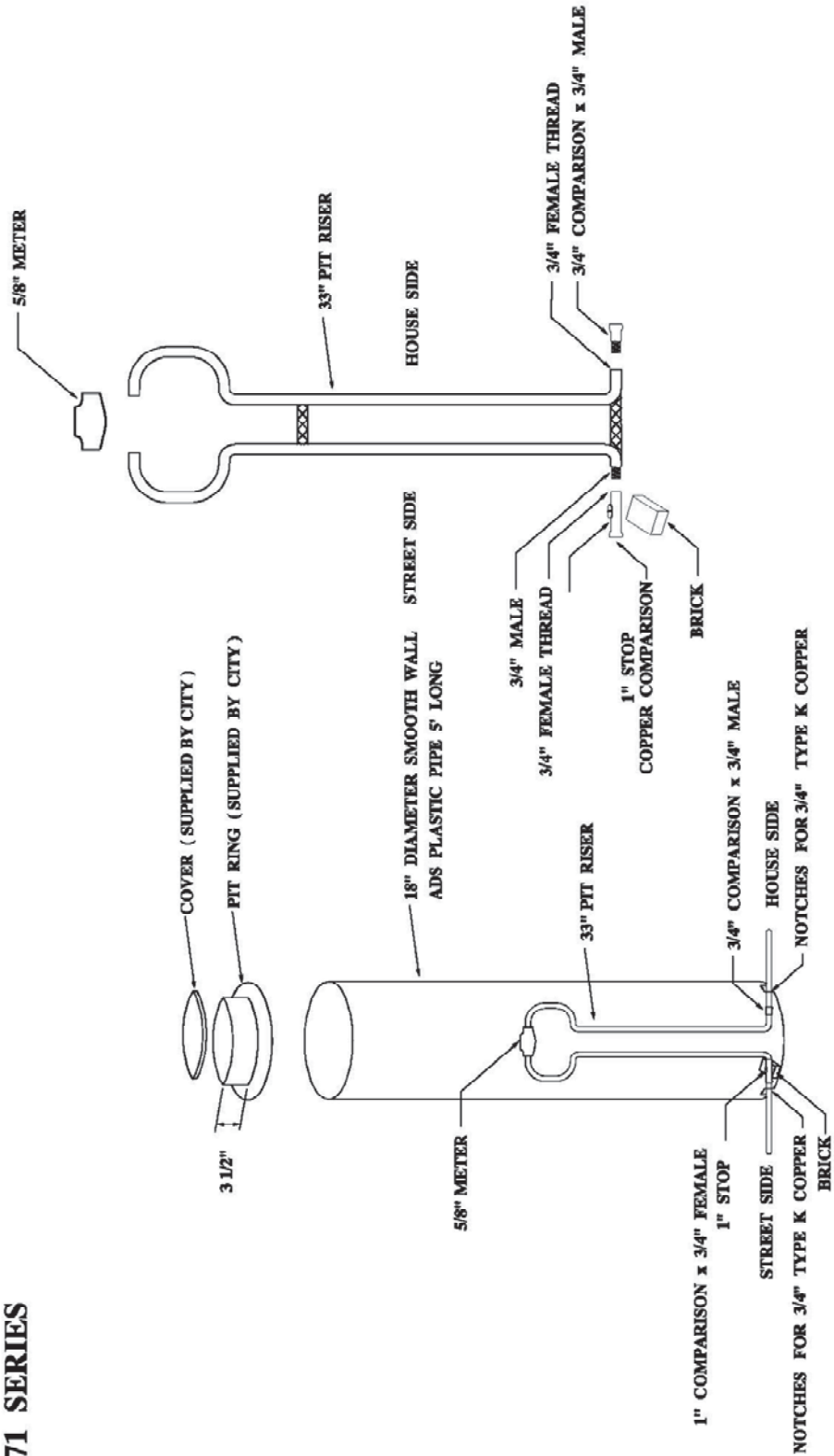

**SPECIAL PROVISION
FOR
WATER MAIN, ABANDON IN PLACE**

City of Owosso/CW

1 OF 2

October, 2019

a. Description. Water main, Abandon in Place shall consist of materials and work meeting requirements of Section 823 of the MDOT 2012 Standard Specifications for Construction, and as modified herein.

b. Materials. Water main pipes to be abandoned shall be filled with self-compacting and self-leveling flowable fill. Flowable fill will consist of a mixture of Portland cement, granular material (fine aggregate), fly ash, and water.

Portland cement will be either Type I or IA and will conform to Section 901 of the Standard Specifications for Construction.

Fly ash will be Class F or Class C and will conform to ASTM C 618 except that the limit for Loss on Ignition will be deleted.

Granular material will meet the requirements of Class II material as specified in Section 902 of the Standard Specifications for Construction except that 100 percent will pass the 13 mm sieve. Fine aggregate will meet the requirements of 2NS material as specified in Section 902 of the Standard Specifications for Construction. Water will meet Section 911 of the Standard Specifications for Construction.

The materials for bulk heading shall include mortar, geotextiles wrap, and tape for attachment. Mortar mix shall be Type H-1 non-shrinking mortar and grout mixture.

c. Construction. The temperature of the flowable fill mixture as manufactured and delivered will be at least 50° F.

Abandon water main by venting and completely filling the pipe with flowable fill. In long closures, provide ventilation taps are required, as directed by the Engineer.

During flowable fill placement operations, care will be used to avoid dislocating any pipes, due to fluid pressure from the flowable fill. Pipelines and other areas not intended to receive flowable fill will be sealed tightly to prevent infiltration.

Seal each exposed remaining ends with bulk heads. The bulk heads shall be constructed such that prepared mortar mix shall be extended at least one foot into the pipe, then wrapped with geotextile material, same as used for the road, and secured in place with tape.

2 OF 2

d. Measurement and Payment. The completed work as measured for Water Main, Abandon in Place will be paid for at the Contract Unit Price for the the following Contract Item (Pay Item):

| Contract Item (Pay Item) | Pay Unit |
|---------------------------------|-----------------|
| Water Main, Abandon in Place | Lft |

Water Main, Abandon in Place will be measured in place by the linear foot and will be paid for at the contract unit price per Lft which price shall be payment in full for all labor, material, and equipment needed to accomplish this work. Bulkheading end points will not be paid for separately, but will be considered as part of the Contract Item.

**SPECIAL PROVISION
FOR
ABANDONED GAS MAIN, CONFLICT**

City of Owosso/RC

1 OF 1

Dec, 2018

General

The work of Abandoned Gas Main, Conflict shall be performed in accordance with Sections 402 and 702 of the MDOT 2012 Standard Specifications for Construction.

Description

The work of Abandoned Gas Main, Conflict consists of removing abandoned gas main, of various size and material, that directly conflicts with proposed storm sewer installation and bulk heading the two exposed ends, as shown on the plans or as directed by the Engineer. The Engineer will determine whether a conflict exists and advise the Contractor in advance of any work.

Materials

The materials for bulk heading shall include mortar, geotextile wrap, and tape for attachment. Mortar mix shall be Type H-1 non-shrinking mortar and grout mixture.

Construction

The Contractor shall expose the existing pipe crossing in advance of proposed construction and confirm with the utility that the pipe is abandoned. The Contractor shall inform the Engineer of the conflict in advance of any work. After agreement is reached, then the Contractor shall remove that portion of conflicting abandoned pipe across the trench influence area and seal each exposed remaining ends with bulk heads. The bulk heads shall be constructed such that prepared mortar mix shall be extended at least one foot into the pipe, then wrapped with geotextile material same as used for the road, and secured in place with tape.

Measurement and Payment

The completed as measured for Abandoned Gas Main, Conflict will be paid for at the Contract Unit Price for the following Contract Item (Pay Item):

| Contract Item (Pay Item) | Pay Unit |
|---------------------------------|-----------------|
| Abandoned Gas Main, Conflict | Each |

Abandoned Gas Main, Conflict will be measured in place by the unit Each; and will be paid for at the contract unit price per Each, which price shall be payment in full for all labor, material, and equipment needed to accomplish this work.

CITY OF OWOSSO
SPECIAL PROVISION
FOR
AGGREGATE BASE, _ INCH, MODIFIED

City of Owosso/RC

1 of 1

Dec, 2018

a. Description. This work shall consist of placing and compacting an aggregate base course on a prepared subbase.

b. Materials. The material shall meet the gradation requirements of the Michigan Department of Transportation (MDOT) 2012 Standard Specifications for Construction, Section 902, for 21AA aggregate, except all material shall be 100% crushed limestone.

c. Construction Methods. The material shall be placed and compacted in accordance with the MDOT 2012 Standard Specifications for Construction, Section 302.03.

d. Measurement and Payment. The completed work, Aggregate Base, _ inch, Modified including all materials, labor, and equipment, as measured will be paid for at the Contract Unit Price for the following Contract Item (Pay Item).

Contract Item (Pay Item)

Pay Unit

Aggregate Base, _ inch, ModifiedSquare Yard

Aggregate Base, _ inch, Modified will be measured in place by the square yard.

The maximum pay width will be as shown on the plans.

a. Description. Provide a film record of physical, structural and aesthetic conditions of the area described in this special provision as it exists prior to the beginning of any construction activities. The film must be professional quality, providing a clear and accurate visual record of existing condition.

Complete filming, under the supervision of the Engineer, before any construction activity is started. Furnish the completed tape to the Engineer one week prior to placement of any materials or equipment in the construction area. Any portion of the tape determined by the Engineer to be unacceptable for the documentation of existing conditions must be re-filmed prior to the start of any construction activity. All costs associated with the need to re-film will be borne by the Contractor.

b. Audio-Video Production. Provide the name of the videotaping services company to the Engineer a minimum of 5 work days prior to the start of taping.

Using color DVD video and equipment which allows audio and video information to be recorded. Do not splice or edit the video. Speed and electronics of the video equipment and DVD must conform to video taping industry standards. Film in the general direction of vehicular travel and do not exceed 45 feet per minute (approximately 0.5 miles per hour). Control pan and zoom rates to ensure playback clarity of the subject matter being filmed.

Use audio and video cues to identify location, relative to project limits and landmarks, at intervals of not more than 100 feet along the filming route. Provide audio commentary as necessary during filming to describe streets, buildings, landmarks and other details which will enhance the documentation of existing conditions.

Conduct filming during a time of good visibility and not during periods of precipitation, or when snow, leaves, or other natural debris obstruct the area being filmed.

Use video equipment with date/time stamp and digital annotation capabilities. The final video recording must display the date (month, day and year) and the time (hours, minutes, and seconds). This transparent information is to appear on the upper left hand corner of the frame.

The project station numbers must appear in the lower half of the frame. This stationing must use MDOT standard engineering symbols (i.e., 3+50). If there is no project stationing in an area being filmed, assign assumed stationing to each street or other discrete area being filmed. Start the assumed stationing at 0+00 and increase from west to east or from south to north. Include periodic, transparent alpha/numeric information below the station numbers consisting of the name of the project, name of area shown, direction of travel, viewing direction, etc.

c. Area to be Filmed. Film all existing driveways, sidewalks, fences, trees, shrubbery and other structures and landscaping located up to 50 feet outside of the proposed right-of-way line shown on the plans and within the limits of construction. The limits of construction consist of E North Street from N Hickory Street to N Gould Street and Summit Street from Abbott Street to Rubelman Drive. The tape coverage must include the exterior of all buildings within the above described limits.

d. Measurement and Payment. The completed work as documented by the DVD(s) will be paid for at the contract unit price for the following contract item.

| Contract Item (Pay Item) | Pay Unit |
|---------------------------------|-----------------|
| Audio Visual Filming | Lump Sum |

Payment for the item **Audio Visual Filming** includes all labor, equipment and materials required to perform the filming and to provide the finished video(s) to the Engineer.

**SPECIAL PROVISION
FOR
CONCRETE PAY ITEMS**

City of Owosso/RC

1 OF 1

Dec, 2018

Description

This work shall be done in accordance with sections 601 and 701 of the MDOT 2012 Standard Specifications for Construction, except as modified herein. This special provision indicates the type of concrete mixture to be used for pay items related to curb and gutter, drive approaches, and sidewalks.

Materials

Cement content for Concrete, Grades S2 and P1, shall be 564 pounds per cubic yard (6 Sack) for all concrete items, in accordance with Sections 601 and 701 of the MDOT 2012 Standard Specifications for Construction. Concrete mix shall not include fly ash or water reducing agents.

Construction

Construction of concrete related items including but not limited to curb and gutter, driveways, sidewalks, ADA ramps shall be done in accordance with the MDOT 2012 Standard Specifications for Construction, or as directed by the Engineer.

Measurement and Payment

Payment for the completed work for the various concrete pay items in this contract using a six full sack mix shall be included as part of their individual unit prices.

**CITY OF OWOSSO
SPECIAL PROVISION
FOR
SIDEWALK RAMP AND DETECTABLE WARNING SURFACE, MODIFIED**

City of Owosso/RC/CW

1 OF 1

October, 2019

Description

This work shall consist of constructing sidewalk ramps and detectable warning surfaces. Complete this work according to the standard specifications, Standard Plan R-28 Series and this special provision.

Materials

The materials shall meet the requirements of the Michigan Department of Transportation (MDOT) 2012 Standard Specifications for Construction, Section 803, for concrete sidewalk except detectable warning systems shall be Duralast™ as manufactured by East Jordan Group, Inc. The detectable warning systems shall be 2.5 feet in length and powder coated red.

Construction

Construct sidewalk ramp according to Section 803 of the MDOT Standard Specifications for Construction and Standard Plan R-28 Series. Depth shall be 7 inches from curb to landing square.

Measurement and Payment

The completed work, as described, will be measured and paid for at the contract unit price using the following contract item (pay item):

| Contract Item (Pay Item) | Pay Unit |
|--------------------------------------|-------------|
| Sidewalk Ramp, Conc, 7 Inch | Square Foot |
| Detectable Warning Surface, Modified | Foot |

Sidewalk Ramp, Conc., 7 Inch will be measured in place by area per square foot and paid for per square foot.

Detectable Warning Surface, Modified will be measured in place by length per foot along the center of the 24 inch wide detectable warning material at specified locations and paid for per foot. Payment includes all labor, materials, and equipment to install detectable warning surface.

CITY OF OWOSSO
SPECIAL PROVISION
FOR
DR STRUCTURE COLLAR, MODIFIED

City of Owosso/CW

1 of 1

Oct, 2019

a. Description. Around existing and proposed storm sewer, sanitary sewer, and water main manholes within the paved surface, after the top course of HMA has been placed, the Contractor shall install concrete collar as described below. Work shall in accordance with Sections 403 & 601 of the Michigan Department of Transportation (MDOT) 2012 Standard Specifications for Construction, or as modified herein.

b. Materials. The materials shall be in accordance with Sections 403 and 601 of the Michigan Department of Transportation 2012 Standard Specifications for Construction. Concrete shall be Grade P1 and thermoplastic concrete form shall be MDOT approved. When approved by the Engineer, the concrete mix may be 7 sack mixture for quick cure.

c. Construction. The Contractor shall core the existing pavement full depth, centered on the drainage structure, remove loose material, remove drainage structure plate, install approved collar, trim collar to heights and slope, reinstall casting, and pour concrete to match road finished surface on new or existing drainage structures as described herein, and as shown in the plans. A sealant shall be placed on the top and bottom of the thermoplastic concrete form. A pourable crack sealant shall be poured around the circumference of the concrete collar creating a seal between the concrete and HMA surface.

Prior to installation of aggregate base, the top of the concrete structure adjustment grade rings or blocks shall be removed to the required elevation to accept the thermoplastic concrete form. The structure shall be located by witness and/or GPS to the center of the proposed cover location. The structure opening shall be temporarily plated and the roadway base and surface shall be constructed adjacent to and over the structure in a contiguous and homogeneous manner to the surrounding road base and surface material. Density requirements over the structure plate for the aggregate base and HMA surface shall be the same as the surrounding material, pursuant to the specifications.

d. Measurement and Payment. The completed work as measured for **Dr Structure Collar, Modified** will be paid for at the contract unit price for the following contract item (pay item).

| Contract Item (Pay Item) | Pay Unit |
|------------------------------------|-----------------|
| Dr Structure Collar, Modified..... | Each |

The work of **Dr Structure Collar, Modified** will be measured by the unit each and will be paid for at the contract unit price per each, which price shall be payment in full for all labor, material, and equipment necessary to accomplish this work. Adjustment of existing storm sewer, sanitary sewer, and water main structures will be paid for as **Dr Structure Cover, Adj, Case _** along with **Dr Structure Collar, Modified**. Manholes that are installed new with this contract will not be paid for **Dr Structure Cover, Adj, Case _**, but this concrete collar will be required and will be paid for as **Dr Structure Collar, Modified**.

**SPECIAL PROVISION
FOR
DRAINAGE STRUCTURE COVER EJ _____**

City of Owosso/CW

1 OF 1

Oct, 2019

General Description

Drainage Structure Cover EJ _____, shall consist of materials and work meeting requirements of Section 403 of the MDOT 2012 Standard Specifications for Construction, and as modified herein.

Cover Description

All covers will be manufactured and supplied by East Jordan Iron Works. Cover types shall match with the pay item cover number.

Measurement and Payment

The completed work as measured for Drainage Structure Cover EJ ____ will be paid for at the Contract Unit Price for the following Contract Item (Pay Item):

| Contract Item (Pay Item) | Pay Unit |
|--|-----------------|
| Drainage Structure Cover EJ 1040 w/ Solid Gasket Sealed Cover | Each |
| Drainage Structure Cover EJ 1040 w/ Vented Gasket Sealed Cover | Each |
| Drainage Structure Cover EJ 7000 | Each |

Drainage Structure Cover EJ _____ will be measured in place by count of Each; and will be paid for at the contract unit price per Each, which price shall be payment in full for all labor, material, and equipment needed to accomplish this work.

CITY OF OWOSSO
SPECIAL PROVISION
FOR
DR STRUCTURE, MODIFIED

City of Owosso/RC

1 of 2

October, 2019

a. Description. The Contractor shall construct **Dr Structure, __ inch dia, Modified** of the size and at the locations as shown on the plans or as directed by the Engineer. Work shall in accordance with Section 403 & 913 of the Michigan Department of Transportation (MDOT) 2012 Standard Specifications for Construction, or as modified herein.

b. Materials. Drainage Structures shall be precast reinforced concrete units manufactured to American Society for Testing Materials (ASTM) C-478 specifications and Section 913 of the Michigan Department of Transportation (MDOT) 2012 Standard Specifications for Construction, with either a cast in place bottom or precast concrete base as detailed on the plans.

The Contractor shall place the drainage structure cover as shown on the plans or as directed by the Engineer.

Provide 4"-12" adjustment area (chimney) above the structure's cone.

Masonry structures will not be allowed to be used on this project, unless approved by the Engineer for special circumstances, or where specifically called for on the Plans.

Thirty-six inch diameter drainage structures (catch basins or inlets) will be allowed to be used on this project, where called for on the plans or where directed by the Engineer.

The Contractor shall provide flexible connectors meeting ASTM C-923 requirements and 'as manufactured' by:

1. Trelleborg - Kor-N-Seal 106-406 and 206 series or approved equal.

c. Measurement and Payment. The completed work as measured for **Dr Structure, inch dia, Modified** will be paid for at the contract unit price for the following contract item (pay item).

| Contract Item (Pay Item) | Pay Unit |
|---|-----------------|
| Dr Structure, __ inch dia, Modified | Each |

The work of **Dr Structure, __ inch dia, Modified** includes the concrete footing, and up to 8' of drainage structure depth. The unit price for **Dr Structure, __ inch dia, Modified** includes the cost of temporary or final grade adjustments of the structure. **Dr Structure, __ inch dia, Modified** will be measured by the unit each and will be paid for at the contract unit price per each, which price shall be payment in full for all labor, material, and equipment necessary to accomplish this work.

If during construction, due to utility conflicts or plan revisions, modifications are required to the piping connection holes or additional taps are required to precast concrete sections, this work will be paid for separately, in the Pay Item for the **Dr Structure, Tap, inch**.

CITY OF OWOSSO
SPECIAL PROVISION
FOR
GEOTEXTILE, SEPARATOR, MODIFIED

City of Owosso/CW

1 of 1

August, 2019

a. Description. The work of **Geotextile, Separator, Modified** shall consist of furnishing and placing geotextile on prepared subgrade. Work shall be in accordance with Sections 308 of the Michigan Department of Transportation (MDOT) 2012 Standard Specifications for Construction, or as modified herein.

b. Materials. Geotextile, Separator, Modified shall meet or exceed products as manufactured by Mirifi 550X, US Fabrics US 270, ADS 315W, or approved equal.

d. Measurement and Payment. The completed work as measured for **Geotextile, Seperator, Modified** will be paid for at the contract unit price for the following contract item (pay item).

Contract Item (Pay Item)

Pay Unit

Geotextile, Separator, ModifiedSquare Yard

The work of **Geotextile, Separator, Modified** will be measured in place by area in square yards and will be paid for at the contract unit price per square yard which price shall be payment in full for all labor, material, and equipment necessary to accomplish this work. Overlaps, cutting, and fitting of Geotextile, Separator, Modified will not be measured and paid for separately, but are considered included as part of the in-place area measure of the Geotextile, Separator, Modified.

MICHIGAN
DEPARTMENT OF TRANSPORTATION

SPECIAL PROVISION
FOR
TEMPORARY PEDESTRIAN TYPE II BARRICADE

OFS:RAL

1 of 2

APPR:CAL:CT:08-02-16

a. Description. This work consists of furnishing, installing, maintaining, relocating, and removing a temporary pedestrian Type II barricade section as identified in the proposal or on the plans. Use temporary pedestrian Type II barricades to close non-motorized facilities including sidewalks, bicycle paths, pedestrian paths, and shared use paths that are not part of the roadway. One pedestrian Type II barricade is defined as a barricade section at least 43 inches wide, including all supports, ballast, and hardware.

b. Materials. Provide a temporary pedestrian Type II barricade that meets the requirements of *National Cooperative Highway Research Program Report 350 (NCHRP 350)* or *Manual for Assessing Safety Hardware (MASH)*, in addition to meeting the following requirements:

1. Provide barricade sections at least 43 inches wide, designed to interconnect to ensure a continuous *Americans with Disabilities Act (ADA)* compliant tactile barrier. Ensure the connection includes provisions to accommodate non-linear alignment as well as variations in elevation at the installation area.

2. Ensure the top surface of the barricade is designed to function as a hand-trailing edge, and has a height between 32 and 38 inches. Ensure the lower edge of the barricade is no more than 2 inches above the surface of the non-motorized facility. Ensure the top edge of the bottom rail of the barricade is a minimum of 8 inches above the surface of the non-motorized facility. The barricade may have a solid continuous face. Finally, all features on the front face of the barricade (the face in contact with pedestrians) must share a common vertical plane.

3. Equip both sides of the barricade with bands of alternating 6-inch wide orange and white vertical stripes of reflective sheeting. Two bands of sheeting 6 inches tall and a minimum of 36 inches long containing at least two orange and two white stripes each are required. One band placed near the top and one near the bottom if the barricade section has a solid face. If the barricade consists of two rails, affix one band of sheeting to each rail. Ensure the stripes of reflective sheeting are aligned vertically. Ensure this sheeting meets or exceeds the requirements of *ASTM D 4956* Type IV sheeting.

c. Construction. Construct the temporary pedestrian Type II barricade in accordance with the manufacturer's recommendations, Michigan Manual on Uniform Traffic Control Devices (MMUTCD), the plans, and the following requirements:

1. Install the barricade as shown on the plans and as directed by the Engineer. Interconnect all barricade sections using hinge components if necessary to ensure a continuous detectable edge for the entire installation. Ensure the barricade is ballasted according to the manufacturer's recommendations to ensure stability during wind events and contact with pedestrians.

2. When the barricade is installed near motor vehicle traffic, ensure reflective sheeting is visible to motorists.

3. When pedestrian Type II barricades are used to close a non-motorized facility, ensure a sufficient number of barricade sections are used to block the entire width of the facility. The barricade may extend outside the edge of the non-motorized facility but must not be less than the full width of the facility.

4. If sections of multiple colored barriers are used (i.e. safety orange and white) install the sections such that the colors alternate to increase conspicuity.

5. Ensure pedestrian Type II barricades are not used to close a motor vehicle facility. Ensure these barricades are not used to guide pedestrian traffic on a motor vehicle facility in the presence of active traffic. This prohibition includes bicycle/shared use lanes or shoulders in the presence of active traffic.

d. Measurement and Payment. The completed work, as described, will be measured and paid for at the contract unit price using the following pay item:

| Pay Item | Pay Unit |
|--|-----------------|
| Pedestrian Type II Barricade, Temp | Each |

Pedestrian Type II Barricade, Temp, includes all labor, equipment, and materials to furnish, install, maintain, relocate, and remove one barricade section that is at least 43 inches wide. Additional payment will not be made if wider sections are provided. This includes all rails, supports, ballast, hinge points, reflective sheeting, and miscellaneous hardware needed to install and maintain a barricade section.

**SPECIAL PROVISION
FOR
SANITARY SERVICE, CONFLICT**

City of Owosso/RC

1 OF 1

Dec, 2018

Description

The work of Sanitary Service, Conflict consists of relocating (lowering) existing sanitary service connections that conflict with proposed storm sewer installation as shown on the plans or as directed by the Engineer. The work must be coordinated with City of Owosso DPW officials.

Materials

The materials for relocating existing sanitary sewer service connections shall consist of new material meeting the requirements of the City of Owosso. City DPW officials will review with the Contractor the type of material found, then determine suitable new material and adaptors required to reconnect the sanitary service.

Construction

The City of Owosso will be responsible for temporarily shutting off the wastewater system. The Contractor shall cooperate with City of Owosso DPW officials in establishing service relocation, material selection, and work method in order to reroute the sanitary service under the proposed storm sewer. The entire crossing area shall be filled with 6A compacted crushed stone, from bottom of pipe to one foot above top of pipe. A geotextile separator shall be laid on top the stone backfill. Granular Material, Class II shall be placed and compacted from the geotextile separator to plan grade.

Measurement and Payment

The completed as measured for Sanitary Service, Conflict will be paid for at the Contract Unit Price for the following Contract Item (Pay Item):

| Contract Item (Pay Item) | Pay Unit |
|---------------------------------|-----------------|
| Sanitary Service, Conflict | Each |

Sanitary Service, Conflict will be measured in place by the unit Each; and will be paid for at the contract unit price per Each, which price shall be payment in full for all labor, material, and equipment needed to accomplish this work.

SPECIAL PROVISION
FOR
SAWCUTTING

City of Owosso/RC

1 of 1

Feb, 2017

Description

This work shall be accomplished in accordance with Section 501 of Michigan Department of Transportation 2012 Standard Specifications for Construction except as modified herein.

Construction

This item shall be for sawing HMA pavement, driveway approaches, sidewalks, and curb and gutter; wherever a joint of any does not exist; as shown on the plans and/or as directed by the Engineer. Sawcutting depths shall be full depth.

Measurement and Payment

The completed work as measured for Sawcutting will be paid for at the contract unit price for the following contact item (Pay Item).

| Pay Item | Pay Unit |
|-----------------|-----------------|
| Sawcutting | Linear Foot |

Sawcutting will be measured by length in feet; and will be paid for at the contract unit price per foot, which price shall be payment in full for all labor, material, and equipment needed to accomplish this work.

**CITY OF OWOSSO
SPECIAL
PROVISION FOR
SEWER SDR-26**

City of Owosso/RC

1 of 1

Dec, 2018

a. Description. The work of Sewer, SDR-26, _ inch, Tr Det __, Modified, shall consist of excavation, furnishing and placing plastic sewer pipe, and trench backfill, in accordance with section 402 of the Michigan Department of Transportation (MDOT) 2012 Standard Specifications for Construction, Michigan Department of Transportation Standard Plan R-83 series and the details within the construction plans, except as modified herein.

b. Materials. Materials for sewer pipe shall meet or exceed ASTM D-3034 SDR-26 or ASTM D-2241 SDR-26 specifications for PVC integral gasket sewer pipe, depending on pipe diameter. Material for backfill shall be in accordance with the details within the standard plan R-83 series.

c. Construction. The extensions/connections to existing culverts/sewers on this project will require a FERNCO coupler to obtain a tight seal at the joint connecting new pipe to existing pipe. The joint between the existing and new pipes shall be constructed according to the 2012 MDOT Standard Specifications for Construction and as directed by the Engineer. Any extra work required to obtain tight joints will not be paid for separately but will be included in compensation for new pipe. Sewer trench shall meet requirements of Trench Detail B, Modified, as shown on the plans.

d. Measurement and Payment. The completed work as measured for Sewer, SDR-26, _ inch, Tr Det __, Modified will be paid for at the contract unit price for the following contract item (pay item).

| Contract Item (Pay Item) | Pay Unit |
|--|-----------------|
| Sewer, SDR-26, _ inch, Tr Det __, Modified | Foot |

Sewer, SDR-26, _ inch, Tr Det __, Modified will be measured in place by length in feet and will be paid for at the contract unit price per foot which price shall be payment in full for any Fernco fittings, connecting to existing sewers, neoprene gaskets, couplers, sheeting or shoring trench walls, backfill as required and all labor, material and equipment needed to accomplish this work.

General:

American Iron and Steel Contract Language

Description:

The Contractor acknowledges to and for the benefit of the city of Owosso ("Purchaser") and the Michigan Department of Environmental Quality (the "State") that it understands the goods and services under this Agreement are being funded with monies made available by the State Revolving Fund and/or the Drinking Water Revolving Fund and such law contains provisions commonly known as "American Iron and Steel (AIS);" that requires all iron and steel products used in the project be produced in the United States ("AIS Requirements") including iron and steel provided by the Contractor pursuant to this Agreement. The Contractor hereby represents and warrants to and for the benefit of the Purchaser and the State that (a) the Contractor has reviewed and understands the AIS Requirements, (b) all iron and steel used in the project will be and/or have been produced in the United States in a manner that complies with the AIS Requirements, unless a waiver of the requirements is approved or the State made the determination in writing that the AIS Requirements do not apply to the project, and (c) the Contractor will provide any further verified information, certification or assurance of compliance with this paragraph, or information necessary to support a waiver of the AIS requirements, as may be requested by the Purchaser. Notwithstanding any other provision of this Agreement, any failure to comply with this paragraph by the Contractor shall permit the Purchaser or State to recover as damages against the Contractor any loss, expense or cost (including without limitation attorney's fees) incurred by the Purchaser or State resulting from any such failure (including without limitation any impairment or loss of funding, whether in whole or in part, from the State or any damages owed to the State by the Purchaser). While the Contractor has no direct contractual privity with the State, as a lender to the Purchaser for the funding of its project, the Purchaser and the Contractor agree that the State is a third-party beneficiary and neither this paragraph (nor any other provision of this Agreement necessary to give this paragraph force or effect) shall be amended or waived without the prior written consent of the State.

MICHIGAN
DEPARTMENT OF TRANSPORTATION

SPECIAL PROVISION
FOR
TURF ESTABLISHMENT, PERFORMANCE

DES:JLB

1 of 5

APPR:DMG:LML:01-13-15

a. Description. For the work identified in this special provision paid for by the pay item Turf Establishment, Performance only, delete section 816 of the Standard Specifications for Construction and replace it with this special provision. The Contractor is responsible for the performance and quality of turf growth in the areas indicated on the plans and as identified by the Engineer. Comply with all local, state and federal laws when completing this work.

Establish a durable, permanent, weed-free, mature, perennial turf. The work consists of fundamental turf work, including but not limited to topsoiling, seeding, mulching, erosion control, maintenance, watering and repair of turf as described herein during the life of the contract and during the life of any supplemental performance bond which may ensue.

Choose and implement proven turf establishment industry practices; provide all necessary labor and equipment; select and provide all turf establishment materials; and control erosion and any subsequent sedimentation at all times.

Perform a site analysis, interpret the results and implement a turf establishment program to ensure compliance with this specification. The site analysis must take into consideration topsoil needs, fertilizer and pH requirements, seed mix, existing and future soil moisture levels, slopes and grades, required erosion control items and devices, maintenance requirements, local highway snow removal and deicing practices, and any other characteristics that influence and affect turf establishment.

Subsection 107.11 of the Standard Specifications for Construction is revised relative to the Contractor's responsibility for the repair of turf establishment work as follows. The Contractor is responsible, at no additional cost to the contract, for the repair of turf establishment work occasioned by storm events up to 3 inches of rain in a 24 hour period as documented by local meteorological data submitted to the Engineer for review and approval. All other portions of subsection 107.11 remain unchanged.

1. Contractor Turf Establishment Experience Requirements. Ensure weed control is done by a commercial herbicide applicator, licensed by the State of Michigan and certified by the Michigan Department of Agriculture (MDA) in the appropriate category to apply herbicides. Use application procedures and materials according to federal, state and local regulations. Use of restricted use chemicals is prohibited. Provide appropriate documentation and secure approval from the Engineer before application of herbicides.

At least 10 work days prior to start of turf establishment, provide documentation to the Engineer, from the Contractor performing the turf establishment work, that they meet one or both of the following requirements.

A. At least one person employed by the Contractor performing the turf establishment work and assigned to the job site has a degree or certificate in Turf

Management, Horticulture or related field.

B. At least one person employed by the Contractor performing the turf establishment work and assigned to the job site has at least 5 years of experience in roadside turf establishment.

b. Materials. Provide topsoil, seed, mulch, pesticide, herbicide, mulch blankets and any other unique erosion control materials as necessary to fulfill this specification, as detailed on the plans. Use additional materials, as necessary, to meet the standards set forth for turf establishment in this special provision. The use of sod on the project requires the prior approval of the Engineer and if approved, may be used at limited site locations only.

Selection of all materials is the responsibility of the Contractor with the following minimum conditions.

1. Soil. Provide furnished or salvaged topsoil, which may be blended compost, that will support vigorous growth. Ensure topsoil is humus bearing and placed at least 4 inches deep. Ensure it is free of stones larger than 1/2 inch (2 inches on freeway projects) in diameter and other debris. Trim and grade the finished slope in accordance with subsection 205.03.N of the Standard Specifications for Construction.

2. Seed. Use a seeding mixture that is composed of four or more species of perennial grass. Use only species and their cultivars or varieties which are guaranteed hardy for Michigan.

Recommended species of perennial grasses include: Kentucky Bluegrass, Perennial Ryegrass, Hard Fescue, Creeping Red Fescue, Chewings Fescue, Turf-type Tall Fescue, Buffalo grass, and Alkaligrass-Fulfs Puccinellia distans. Select cultivars or varieties of grasses that are disease and insect resistant and of good color. Ensure that no one species in the mix is less than 5 percent, or more than 25 percent, of the mixture by weight. Do not select grass species considered noxious or objectionable, such as Quack Grass, Smooth Brome, Orchard Grass, Reed Canary Grass and others.

A. Ensure the seed is legally saleable in Michigan. Ensure the seed product does not contain more than 10 percent inert materials. Ensure the seed source is an MDOT approved certified vender.

B. Adapt the species and varieties of seed to the site conditions, to the site use, and to the soils, moisture and local climate. Site use may include, but is not limited to, detention pond, wildlife habitat, playground, wetlands, forested wetland, rural roadside, urban roadside and highly maintained front yard.

C. Ensure at least two of the species in the mixture proposed to be planted within 15 feet behind the curb or the shoulder are salt tolerant.

3. Mulch. Mulch seeded areas with the appropriate materials for the site conditions to promote germination and growth of seed and to mitigate soil erosion and sedimentation.

4. Herbicides. Comply with all federal, state and local laws. As part of the MDA weed control application, the Contractor is required to make proper notifications and/or postings as per label and MDA requirements for all locations that will be sprayed. Notify the Engineer at least 48 hours prior to any applications being made. Furnish and apply herbicide(s) as

needed. It is the Contractor's responsibility to select the herbicide(s) and the rate at which it is used. Obtain the Engineer's approval of work methods and herbicide(s) selected prior to the application of the herbicide(s). Complete a spray log and submit to the Engineer each day an application is made.

Do not draw water from any waterway (i.e. river, ditch, creek, lake etc.) located on state, county or municipal right-of-way, for mixing with herbicides.

5. Fertilizers. Furnish and apply fertilizer(s) as needed. It is the Contractor's responsibility to select the fertilizer(s) and the rate at which it is used. Phosphorus is allowed for use only at the time of planting and when required by soil conditions. Obtain the Engineer's approval of work methods and fertilizer(s) prior to the application of the fertilizer(s).

6. Water. Furnish and apply water from an approved source at a rate to promote healthy growth.

c. Construction. The Contractor is responsible for all work and all construction methods used in completing this work. Implementation of any part of the standard specifications or standard plans by the Contractor does not relieve the Contractor of responsibility for acceptability of the construction methods or for the quality of the work.

1. Inspection of the Work. The Contractor is responsible for all inspection of turf establishment work.

Use a Contractor's Daily Report, approved by the Engineer, to report inspections made and to document turf establishment work performed on this project. Complete and submit a Contractor's Daily Report to the Engineer when any work performed under this special provision is in progress.

Include all necessary materials documentation including tests slips, certifications, etc. with the associated Contractor's Daily Report.

The Engineer will determine the acceptability of the Contractor's Daily Report in terms of their completeness and accuracy. The Engineer reserves the right to verify all submitted measurements and computations. Failure by the Contractor to submit acceptable and timely reports to the Engineer may result in withholding of progress pay estimates on turf-related items until such time as reports are submitted and deemed acceptable.

The Engineer reserves the right to inspect the project for any reason in accordance with subsection 104.01 of the Standard Specifications for Construction, including the fulfillment of other inspection requirements such as Soil Erosion and Sedimentation Control, NPDES, etc. Inspections made by the Engineer do not relieve the Contractor of the responsibility for inspections required by this special provision or the Contractor's responsibilities for erosion control and turf establishment.

2. Erosion Control. Control erosion at all times according to section 208 of the Standard Specifications for Construction. Control of soil erosion is the responsibility of the Contractor. However, sedimentation controls must be placed as indicated on the plans or as directed by the Engineer. Continuously monitor the site for needed erosion repair from any cause as addressed in the contract. Return all eroded areas to original grade as detailed in the contract.

Take immediate corrective action if sedimentation occurs in drainage structures or any watercourse or water containment area and stabilize all disturbed areas contributing to this sedimentation within 24 hours after the erosion occurrence. Remove sediment deposited as a result of the Contractor's inability to control the soil erosion at the Contractor's expense.

Reimburse the Department for any costs levied against the Department, such as fines, environmental costs, costs for remedies required, or any other costs as a result of the Contractor's failure to comply with this special provision and with federal, state and local laws.

3. Erosion Repair. The Contractor is responsible for all repairs and liable for all consequences (legal, monetary or other) associated with erosion or sedimentation damage to finished or unfinished work.

Report all erosion occurrences and the repairs made by the Contractor to the Engineer in the format and at the frequency required by the Engineer. Repair any erosion, displacement or disturbance to ongoing or completed work by any cause at no additional cost to the contract unless otherwise noted herein.

The Contractor is responsible and liable for all traffic control and safety measures required to repair and protect damaged turf areas. Repair any eroded area that may affect the support of the roadbed or safety of the public within 24 hours of the erosion occurrence.

Place protective devices such as barriers, directional signs/signals, temporary fence, or any other safety measures immediately after any erosion damage occurs that has the potential of endangering the public. In these instances, provide the Engineer with a written summary of the immediate action taken describing the repairs made and the safety measures taken, within 24 hours of the occurrence of the damage.

4. Mowing and Weeding. Maintain turf to a visually appealing level, and not more than 8 inches in height at any time, prior to acceptance. Weeds must be controlled to less than 10 percent of the turf establishment area at all times during construction.

5. Final Acceptance and Supplemental Performance Bond.

A. Final Acceptance Parameters. Ensure before final acceptance of the turf establishment work, all of the following minimum parameters are met throughout all exposed areas of the project designated on the plans or identified by the Engineer as turf establishment areas: there must be no exposed bare soil and the turf must be fully germinated, erosion free, weed free, disease free, dark green in color and in a vigorous growing condition.

The Engineer will notify the Contractor of the dates and times of all acceptance inspections. The Contractor may accompany the Engineer during these inspections. If the Contractor does not agree with the decision made by the Engineer, the Contractor may request an inspection by a mutually agreed upon third party (Michigan State University Extension service or other). A joint inspection, to include the Engineer, the Contractor, and the third party, will be scheduled by the Engineer. Pay all expert fees and expenses charged by the third party.

B. Supplemental Performance Bond. In the event that all contract items of work are

completed, including the placement of all turf establishment items of work, and the final acceptance of the project is delayed because the final acceptance parameters for the turf establishment work have not been fully met; the Contractor may propose to the Engineer the use of a supplemental performance bond.

The bond serves to secure the successful completion of turf establishment work and fulfillment of all final acceptance parameters for the turf establishment work. Ensure the supplemental performance bond, in all respects, is satisfactory and acceptable to the Department and executed by a surety company authorized to do business with the State of Michigan.

Ensure the bond is in an amount equal to 50 percent of the turf establishment work items covered by this special provision. Ensure the bond remains in place for two growing seasons. At the discretion of the Engineer, the bond may be reduced on a prorated basis as portions of the areas designated for turf establishment on the project meet the final acceptance parameters.

Prior to commencement of any work necessary to meet the acceptance parameters during the bonded period, the Contractor must apply for a permit to work within MDOT right-of-way using Form 2205. The permit fee and an individual permit performance bond will not be required. The permit insurance requirements, however, will be required.

d. Measurement and Payment. The completed work, as described, will be measured and paid for at the contract unit price using the following pay item:

| Pay Item | Pay Unit |
|--------------------------------------|-----------------|
| Turf Establishment, Performance..... | Square Yard |

Turf Establishment, Performance will include all labor, equipment and materials required or selected by the Contractor to install, maintain, inspect, repair and meet the acceptance parameters for turf establishment specified in this special provision, including preparation, updating and submittal of the Contractor's Daily Reports.

Repairs made to damaged turf establishment areas as a result of a documented storm by local meteorological data resulting in rainfall amounts of more than 3 inches in a 24 hour period will be paid for as an increase to original quantities in accordance with subsection 109.05 of the Standard Specifications for Construction.

The following schedule of payment applies to work performed according to this special provision. Upon completion of topsoil surfacing stage, 50 percent of the authorized amount for **Turf Establishment, Performance** will be paid to the Contractor. The remaining 50 percent of the authorized amount will be paid upon completion of all other work necessary to comply with this special provision and to meet all final acceptance parameters for **Turf Establishment, Performance** or at such time as the supplemental performance bond is accepted by the Department.

The supplemental performance bond and all costs associated with turf establishment work performed during the duration of the performance bond will not be paid for separately. These costs which may include, but are not limited to, mobilization, traffic control devices, and the required permit insurance are included in the unit price bid for **Turf Establishment, Performance**.

**SPECIAL PROVISION
FOR
VALVE BOX, ADJ**

City of Owosso/RC

1 OF 1

Dec, 2018

Description

The work of Valve Box, Adj shall be done in accordance with Section 403 of the MDOT 2012 Standard Specifications for Construction, and as modified herein. This work shall include the proper setting and support of valve boxes within the proposed pavement area.

Method of Construction

This work item shall include adjustment of water valve boxes and covers to final grade in advance of the final course of HMA. The Contractor shall sawcut, remove adjacent pavement, center box over the water valve, set and support cover to the required elevation, and replace pavement at equivalent depth with HMA of same type and mix as top course material.

Measurement and Payment

The completed work as measured for Valve Box, Adj will be paid for at the contract unit price for the following contract pay item (Pay Item):

| Contract Item (Pay Item) | Pay Unit |
|---------------------------------|-----------------|
| Valve Box, Adj | Each |

Valve Box, Adj will be measured in in place by the unit Each and will be paid for at the contract unit price per Each, which price shall be payment in full for all labor, material, and equipment needed to accomplish this work.

The unit price for Valve Box, Adj includes the following:

1. Sawcutting existing pavement.
2. Adjusting and supporting the valve box.
3. Removing and replacing HMA adjacent to the adjusted cover.